

Informer® Fluid Monitoring Kits

3A2040E
EN

Use to monitor flow rate and track material use. For professional use only.



Important Safety Instructions

Read all warnings and instructions in this manual. **Save these instructions.**

See the G3000 meter manual (308778) or Coriolis meter manual (313599) for flow meter maximum working pressure.

See page 3 for kit information, including approvals.

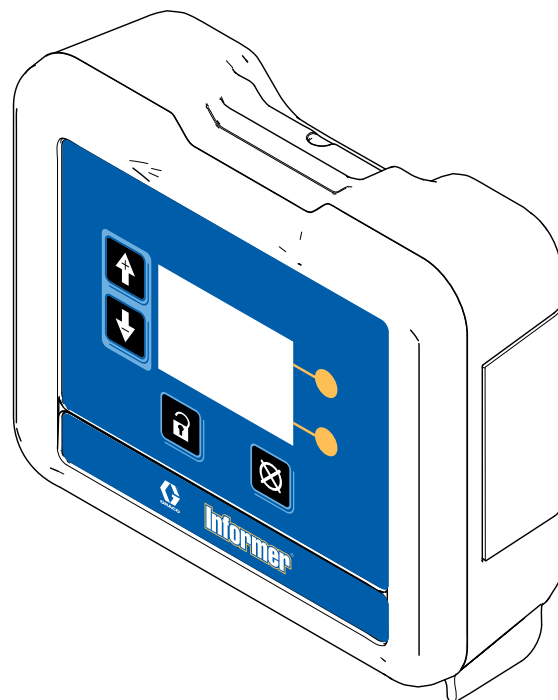

ti17980a



Contents

Informer Models and Kits	3	Screen Navigation and Editing	20
Warnings	5	Icons	21
Installation.....	8	Run Screens	23
Overview	8	Password Screen	24
Non-Hazardous Locations	9	Setup Screens.....	25
Hazardous Locations.....	10	Deviations and Advisories	29
Grounding	12	Troubleshooting.....	30
Cable Connections.....	12	Parts.....	31
Electrical Connections.....	13	Accessories.....	33
Operation.....	16	Mounting Dimensions	34
Pressure Relief Procedure.....	16	Appendix A - Modbus Variable Map	35
Flow Meter Operation.....	16	Appendix B - Advanced Web Interface	37
Meter Calibration	17	Technical Data	41
Setting Modbus Address.....	18	Graco Standard Warranty.....	42
Update Software	18		
Replace Battery	19		
Display Module.....	20		
Display Information	20		
Operation Modes	20		

Informer Models and Kits

All Display Control Modules (DCM) are base model number 24L096 (Ref. 1). Models 24L096 and 24N671 (DCM with bracket) are not available for separate sale. See approval information in Manual 332013 and on this page. The small label (Ref. 2) on the back of the Informer module shows the Informer Kit number. Available kits are described in the tables that follow.

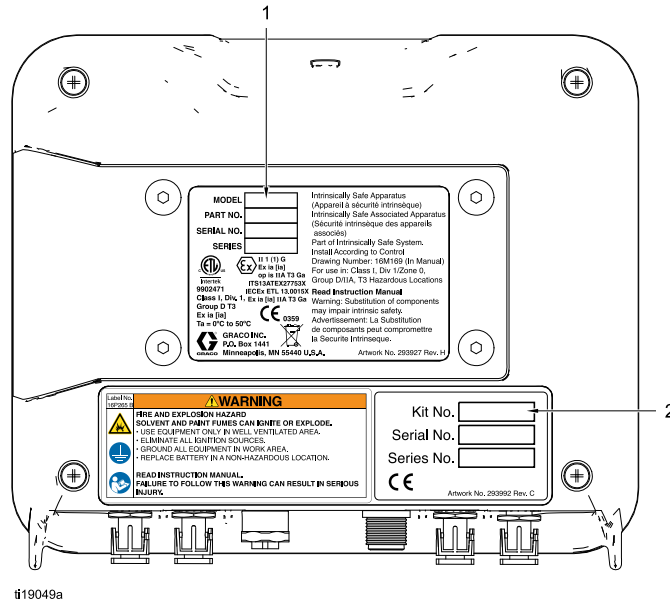

ti19049a

Model No.	Series	Description
24L096	A	Display Control Module (DCM), with no software loaded. See Manual 332013.
24N671	A	Display Control Module (DCM) with bracket, with no software loaded. See Manual 332013.



Intertek

9902471
Class I, Div. 1,
Group D T3
Ex ia [ia]
Ta=0°C to 50°C







**II 1 (1) G
Ex ia [ia]
op is IIA T3 Ga
ITS13ATEX27753X
Ta=0°C to 50°C**



**Ex ia [ia] IIA T3 Ga
IECEX ETL 13.0015X
Ta=0°C to 50°C**

Intrinsically Safe Apparatus
Part of Intrinsically Safe System.
For use in Class I, Division 1, Group D T3 Hazardous Locations
See Manual 332013, Appendix A, Control Drawing 16M169 for entity parameters.

Informer Models and Kits



			
Informer systems are not approved for use in hazardous locations unless all accessories and all wiring meet local, state, and national codes.			



Kits for Hazardous Locations					
Kit No.	Series	Informer Module with Bracket (Manual 332013)*	No Power	AC Power with Barrier**	G3000 Meter (Manual 308778)*
24L073	A	✓	✓		
24L074	A	✓	✓		✓
24L077	A	✓		✓	
24L078	A	✓		✓	✓
		* See component manuals for additional approval information. ** Must not be installed in Hazardous Location.			



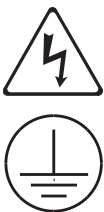

Kits for Non-Hazardous Locations				
Kit No.	Series	Informer Module with Bracket	AC Power	G3000 Meter
24L075	A	✓	✓	
24L076	A	✓	✓	✓
				
Intertek 9902471 Conforms to/Certified to UL/CSA Standard 61010-1				

Warnings

The following warnings are for the setup, use, grounding, maintenance and repair of this equipment. The exclamation point symbol alerts you to a general warning and the hazard symbol refers to procedure-specific risks. When these symbols appear in the body of this manual or on warning labels refer back to these Warnings. Product-specific hazard symbols and warnings not covered in this section may appear throughout the body of this manual where applicable.

 <h2 style="margin: 0;">WARNING</h2>	
	<p>FIRE AND EXPLOSION HAZARD</p> <p>Flammable fumes, such as solvent and paint fumes, in work area can ignite or explode. To help prevent fire and explosion:</p> <ul style="list-style-type: none"> • Use equipment only in well ventilated area. • Eliminate all ignition sources; such as pilot lights, cigarettes, portable electric lamps, and plastic drop cloths (potential static arc). • Keep work area free of debris, including solvent, rags and gasoline. • Do not plug or unplug power cords, or turn power or light switches on or off when flammable fumes are present. • Ground all equipment in the work area. See Grounding instructions. • Use only grounded hoses. • Hold gun firmly to side of grounded pail when triggering into pail. Do not use pail liners unless they are antistatic or conductive. • Stop operation immediately if static sparking occurs or you feel a shock. Do not use equipment until you identify and correct the problem. • Keep a working fire extinguisher in the work area. <p>Static charge may build up on plastic parts during cleaning and could discharge and ignite flammable vapors. To help prevent fire and explosion:</p> <ul style="list-style-type: none"> • Clean plastic parts only in a well ventilated area. • Do not clean with a dry cloth.
	<p>ELECTRIC SHOCK HAZARD</p> <p>This equipment must be grounded. Improper grounding, setup, or usage of the system can cause electric shock.</p> <ul style="list-style-type: none"> • Turn off and disconnect power at main switch before disconnecting any cables and before servicing or installing equipment. • Connect only to grounded power source or grounded electrical outlets. • Use only 3-wire extension cords. • Ensure ground prongs are intact on power and extension cords. • Do not expose to rain. Store indoors. • All electrical wiring must be done by a qualified electrician and comply with all local codes and regulations.

 WARNING	
	<p>INTRINSIC SAFETY</p> <p>Intrinsically safe equipment that is installed improperly or connected to non-intrinsically safe equipment will create a hazardous condition and can cause fire, explosion, or electric shock. Follow local regulations and the following safety requirements.</p> <ul style="list-style-type: none"> Be sure your installation complies with national, state, and local codes for the installation of electrical apparatus in a Class I, Group D, Division 1 Hazardous Location, including all of the local safety fire codes, NFPA 33, NEC 500 and 516, and OSHA 1910.107. Equipment that comes in contact with intrinsically safe terminals must meet the entity parameter requirements specified in Control Drawing 16M169. See Appendix A in Manual 332013. This includes safety barriers, DC voltage meters, ohmmeters, cables, and connections. Remove the unit from the hazardous area when servicing. If a printer, computer, or other electrical component is connected, it must be used in conjunction with a safety barrier. Without the safety barrier, the equipment is no longer intrinsically safe and must not be operated in hazardous locations, as defined in article 500 of the National Electrical Code (USA) or your local electrical code. Do not install equipment approved only for non-hazardous location in a hazardous area. See the ID label for the intrinsic safety rating for your model. Ground the power supply. A voltage limiting safety barrier must be properly grounded to be effective. For proper grounding, use a 12 gauge minimum ground wire. The barrier's ground must be within 1 ohm of true earth ground. Do not operate the power supply module with the cover removed. Do not substitute system components as this may impair intrinsic safety.
	<p>SKIN INJECTION HAZARD</p> <p>High-pressure fluid from gun, hose leaks, or ruptured components will pierce skin. This may look like just a cut, but it is a serious injury that can result in amputation. Get immediate surgical treatment.</p> <ul style="list-style-type: none"> Engage trigger lock when not spraying. Do not point gun at anyone or at any part of the body. Do not put your hand over the spray tip. Do not stop or deflect leaks with your hand, body, glove, or rag. Follow the Pressure Relief Procedure when you stop spraying and before cleaning, checking, or servicing equipment. Tighten all fluid connections before operating the equipment. Check hoses and couplings daily. Replace worn or damaged parts immediately.

 <h1 style="margin: 0;">WARNING</h1>	
  <p style="font-size: small; margin: 0;">MPa / bar / PSI</p>	<p>EQUIPMENT MISUSE HAZARD Misuse can cause death or serious injury.</p> <ul style="list-style-type: none"> • Do not operate the unit when fatigued or under the influence of drugs or alcohol. • Do not exceed the maximum working pressure or temperature rating of the lowest rated system component. See Technical Data in all equipment manuals. • Use fluids and solvents that are compatible with equipment wetted parts. See Technical Data in all equipment manuals. Read fluid and solvent manufacturer's warnings. For complete information about your material, request MSDS from distributor or retailer. • Do not leave the work area while equipment is energized or under pressure. • Turn off all equipment and follow the Pressure Relief Procedure when equipment is not in use. • Check equipment daily. Repair or replace worn or damaged parts immediately with genuine manufacturer's replacement parts only. • Do not alter or modify equipment. Alterations or modifications may void agency approvals and create safety hazards. • Make sure all equipment is rated and approved for the environment in which you are using it. • Use equipment only for its intended purpose. Call your distributor for information. • Route hoses and cables away from traffic areas, sharp edges, moving parts, and hot surfaces. • Do not kink or over bend hoses or use hoses to pull equipment. • Keep children and animals away from work area. • Comply with all applicable safety regulations.
	<p>TOXIC FLUID OR FUMES Toxic fluids or fumes can cause serious injury or death if splashed in the eyes or on skin, inhaled, or swallowed.</p> <ul style="list-style-type: none"> • Read MSDSs to know the specific hazards of the fluids you are using. • Store hazardous fluid in approved containers, and dispose of it according to applicable guidelines.
	<p>PERSONAL PROTECTIVE EQUIPMENT Wear appropriate protective equipment when in the work area to help prevent serious injury, including eye injury, hearing loss, inhalation of toxic fumes, and burns. This protective equipment includes but is not limited to:</p> <ul style="list-style-type: none"> • Protective eyewear, and hearing protection. • Respirators, protective clothing, and gloves as recommended by the fluid and solvent manufacturer.

Installation

Overview

The purpose of the Informer Display Control Module is to collect and display fluid data. The Informer connects the output signal from a meter to a display module that performs the following functions:

- Shows real-time fluid flow rate.
- Displays a resettable batch totalizer.
- Monitors and reports overall fluid use.
- Alarms if the flow rate is too fast or too slow for the user-set targets.
- Alarms when the maintenance total is reached for the user-set target.
- Displays a log of the last 20 alarms.

The Informer is available in configurations for Hazardous Location or Non-Hazardous Location installation. The power supply for Hazardous Locations comes with one barrier, to power one Informer. Up to three additional barriers can be added to the power supply to power three additional Informers. See [Accessories, page 33](#), to order additional barriers and Informer Modules.

Non-Hazardous Locations

NOTE: Non-IS Informer modules are shipped with a 120 VAC power cord (E). Users in areas with another standard voltage must provide a power supply cord with an IEC 320–C13 female connector. See [Technical Data, page 41](#), for power requirements..

or generates more than 250 vrms or d.c. unless it has been determined that the voltage has been adequately isolated.

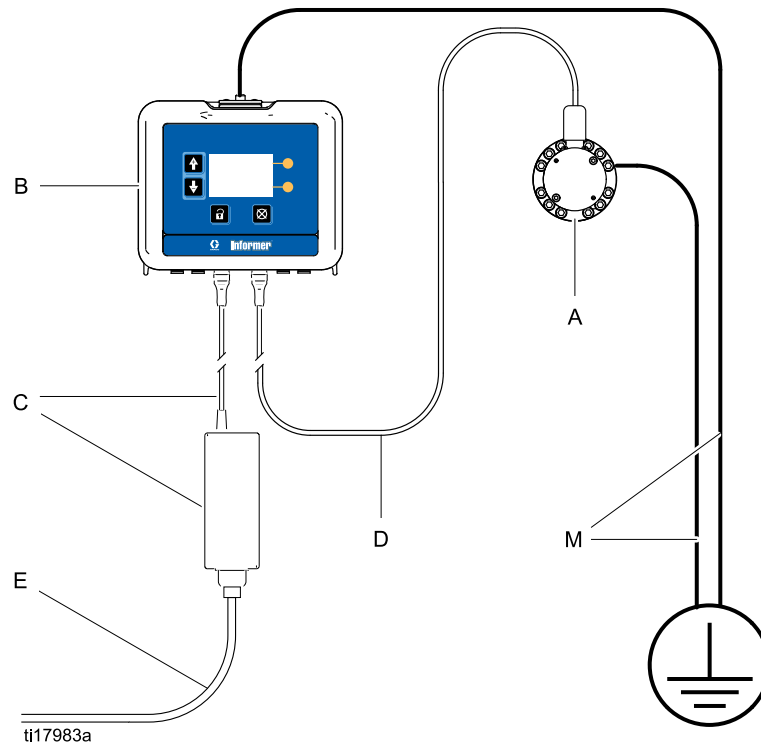

- The nonintrinsically safe terminals (power rail) must not be connected to any device which uses



Key:

- A** Flow Meter, 1/4 npt female inlet/outlet
- B** Informer Module
- C** Power Supply and Cable (6 ft., 2 m), to terminal 3. See [Cable Connections, page 12](#).
- D** Meter Cable (50 ft., 15 m), to terminal 4. See [Cable Connections, page 12](#).
- E** Power Cord (10 ft., 3 m). See NOTE above.
- M** Ground wire and clamp. PN 244524 is included with kits to ground the Informer Module. PN 238909 is sold separately to ground the meter.

Hazardous Locations

		
<p>Do not substitute or modify system components as this may impair intrinsic safety. For installation, maintenance, or operation instructions, read instruction manuals. Do not install equipment approved only for non-hazardous location in a hazardous location. See the identification label for the intrinsic safety rating for your model.</p>		

Intrinsically safe equipment should not be used with a power supply that has no barrier. Do not move units from a non-IS setup to an IS setup. IS equipment that has been used with a non-IS power supply must not be returned to a hazardous location. Always use an intrinsically safe power supply with IS equipment.

- Installation should be in accordance with ANSI/ISA RP12.06.01, "Installation of Intrinsically Safe Systems for Hazardous (Classified) Locations," and the National Electrical Code® (ANSI/NFPA 70).
- Installation in Canada should be in accordance with the Canadian Electrical Code, CSA C22.1, Part 1, Appendix F.
- For ATEX, install per EN 60079-14 and applicable local and national codes.
- Multiple earthing of components is allowed only if a high integrity equipotential system is realized between the points of bonding.
- Do not remove any cover until power has been removed.
- Install according to Control Drawing Number 16M169. See Appendix A in Manual 332013.

Nonhazardous Location

Hazardous Location

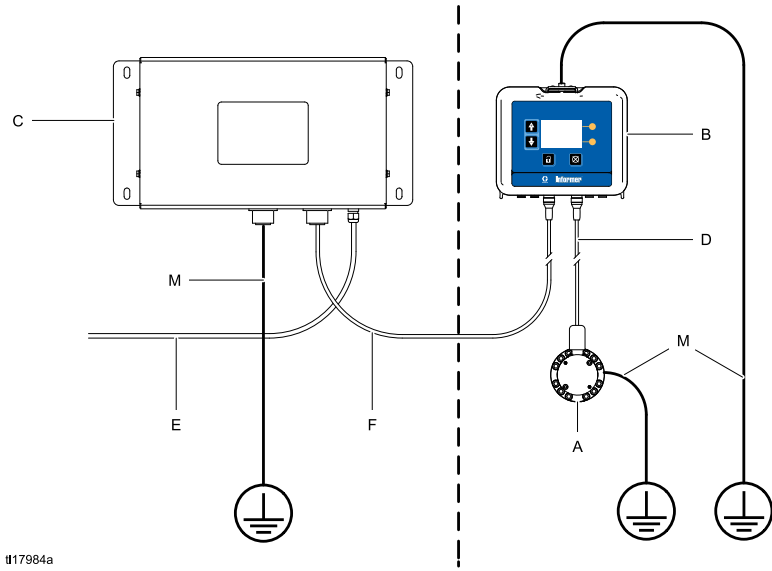





tt17984a

KEY:

- A** Flow Meter, 1/4 npt female inlet/outlet.
- B** Informer Module
- C** Power Supply with Barrier
- D** Meter Cable (50 ft., 15 m), to terminal 4. See [Cable Connections, page 12](#).
- E** Power Cord (not supplied)
- F** Power Cable (50 ft., 15 m), to terminal 3. See [Cable Connections, page 12](#).
- M** Ground wire and clamp. PN 244524 is included with kits to ground the Informer Module. PN 238909 is sold separately to ground the meter or power supply.

Grounding

					
<p>The equipment must be grounded to reduce the risk of static sparking and electric shock. Electric or static sparking can cause fumes to ignite or explode. Improper grounding can cause electric shock. Grounding provides an escape wire for the electric current.</p>					

NOTE: The Informer does not provide 500 VAC isolation through the coupling nuts on the enclosure. The associated apparatus and the field apparatus cable shields must not be connected to the Informer coupling nuts.

1. **Power Supply 16M167:** Connect the ground wire from the power supply to a true earth ground.
2. **Informer Module:** Connect a ground wire and clamp to the screw on the top of the bracket. Connect the other end to ground. In an IS system, the Informer also is grounded by connection to the grounded power supply.
3. **Flow Meter:** Follow the instructions in manual 308778 (G3000) or manual 313599 (Coriolis) to ground the flow meter and check its electrical grounding continuity.
4. **Fluid Supply:** Ground the fluid supply unit.

Cable Connections

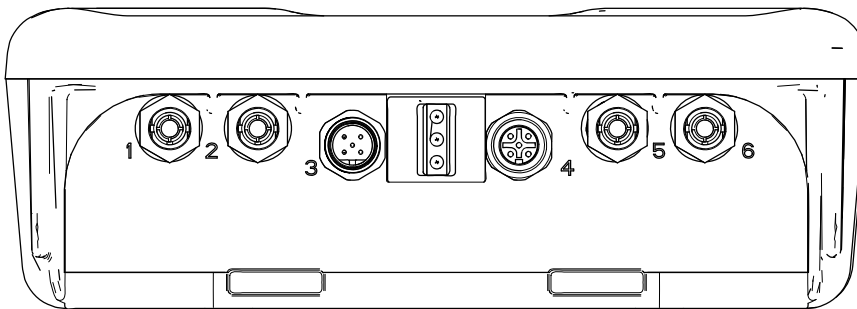

ti19082a

Port	Description	Connection
1	Fiber Optic Receiver	Red Lead from TX on Fiber Optic Converter (PN 16K465) or from Port 6 on another Informer (or ProControl 1KE)
2	Fiber Optic Transmitter	Black Lead to RX on Fiber Optic Converter (PN 16K465) or to Port 5 on another Informer (or ProControl 1KE)
3	Power	From Power Supply
4	Digital Input/Output	To/From Meter and to Light Tower (accessory)
5	Fiber Optic Reciever	Black Lead from Port 2 on another Informer (or ProControl 1KE)
6	Fiber Optic Transmitter	Red Lead to Port 1 on another Informer (or ProControl 1KE).

Electrical Connections

Install per Graco Control Drawing 16M169, in Manual 332013. See also Figure 1.

1. Connect main power supply cord (E, not supplied) through strain relief to terminals L and N on the power supply unit.
Note: Use either strain relief (5) or (6), depending on the size of the cord.
2. Connect power cord ground wire to ground terminal block.
3. Connect IS power cable (F) per the following table.

Power Cable Leads	Barrier Connection
Brown (power)	Connector 1
Blue (common)	Connector 2
Glossy Black (ground) and Black (drain) connect to ground block.	

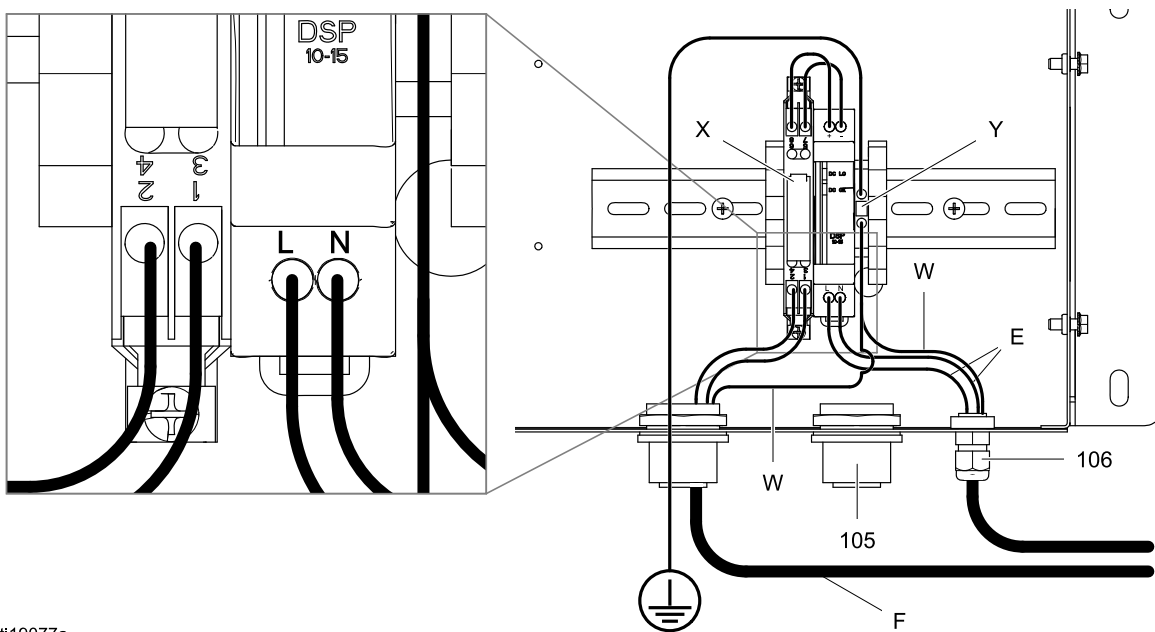

ti19077a

Figure 1

KEY

- E Inbound AC Power Cord
- F Power Cable to Informer
- W Ground Wires
- X Barrier
- Y Ground Block
- 5 Strain Relief Fitting
- 6 Strain Relief Fitting

Typical Installation

Non-Hazardous Location

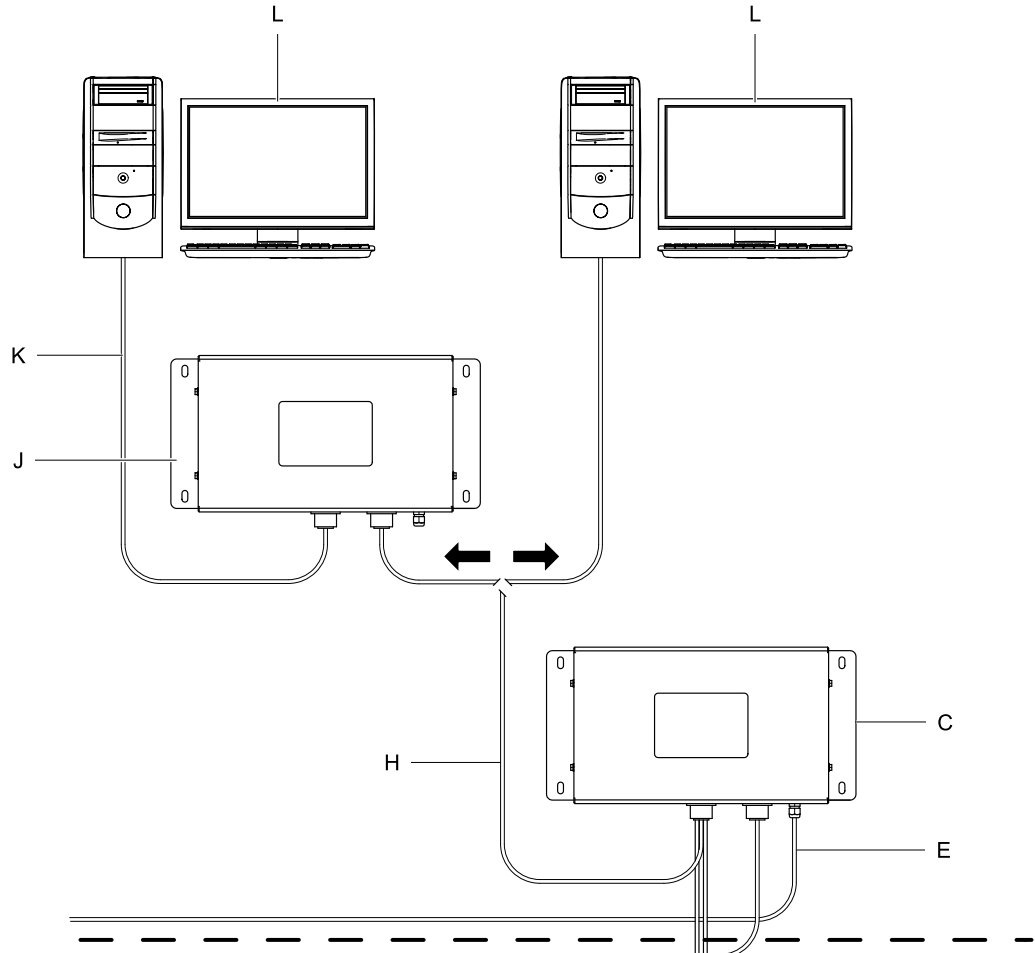

Hazardous Location

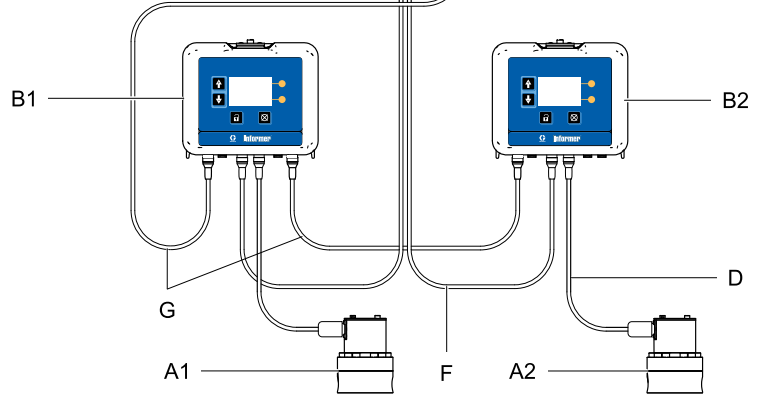

ti19072a

A1 and A2	Flow Meters	Supplied in some kits. See Parts, page 31 .
B1 and B2	Informer Module	Supplied.
C	Power Supply and Barrier	Supplied in Hazardous Location Kits
D	Meter Cable (50 ft., 15 m)	Supplied.
E	Power Cord (10 ft., 3 m)	Supplied in Non-Hazardous Location Kits
F	Power Cable (50 ft., 15 m)	Supplied
G	Fiber Optic Cable	Accessory. See Accessories, page 33 .
H	Serial Cable	Accessory. See Accessories, page 33 .
J	Advanced Web Interface	Accessory. See Accessories, page 33 .
K	Ethernet Cable	Accessory. See Accessories, page 33 .
L	Personal computer	Not supplied.

Communication Options

Graco Accessories are available to enable communication with a Programmable Logic Controller (PLC) or Personal Computer (PC).

- The Fiber Optic Converter (Graco Kit 24N978) enables Modbus RTU communication with a user-supplied PLC using a serial cable.
- A Modbus Gateway (Graco Kit 24N977) used with a Fiber Optic Converter (Graco Kit 24N978) enables Modbus TCP communication with a user-supplied PLC.
- A Modbus Gateway (Graco Kit 24N977) can be connected to (or installed in) an Advanced Web Interface (Graco Kit 15V337) to enable communication with a PC using an ethernet cable. See [Appendix B - Advanced Web Interface, page 37](#), for instructions.

These communication kits come with installation and setup directions necessary for their use with the Informer.

Operation



Pressure Relief Procedure

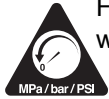

Follow the Pressure Relief Procedure whenever you see this symbol.



This equipment stays pressurized until pressure is manually relieved. To help prevent serious injury from pressurized fluid, such as skin injection, splashing fluid and moving parts, follow the Pressure Relief Procedure when you stop spraying and before cleaning, checking, or servicing the equipment.

1. Turn off the fluid supply to the meter.
2. Shut off all power to the fluid system.

3. Follow the **Pressure Relief Procedure** for your fluid system dispensing device.

Flow Meter Operation



To reduce the risk of component rupture, which could cause injury from splashing fluid, do not exceed the maximum working pressure of your meter or any component or accessory in your system.

For information on the G3000 Graco flow meter, see manual 308778. For information on the Coriolis flow meter, see manual 313599. Calibrate the meter as instructed before using the meter for production.

NOTICE

The flow meter gears and bearings can be damaged if they rotate at too high a speed. To avoid high speed rotation, open the fluid valve gradually. Do not over-speed the gear with air or solvent. To prolong meter life, do not use the meter above its maximum flow rate.

Meter Calibration

NOTE: See **Setup Screen 4** for further screen information, if needed.

When to Calibrate

- The first time the system is operated.
- Whenever new materials are used in the system, especially if the materials have viscosities that differ significantly.
- As part of regular maintenance to retain meter accuracy.
- Whenever a flow meter is serviced or replaced.





Read Before Calibration

- Meter k-factor on **Setup Screen 4** is updated automatically after the calibration procedure is











completed. You also may manually edit the k-factor if desired.

- All values on this screen are in cc or cc/pulse, regardless of the units set in the other Setup screens.
- Before calibrating the meter, be sure the system is primed with material.
- Disable alarms before calibration.



Calibration Steps

1. Press  to enter Setup Mode.
2. Press  to move to Setup Screen 4.
3. Press  to enter the screen.
4. Press  to begin the calibration.

Operation

5. Dispense about 300–500 cc of material into a graduated cylinder. The amount the system measures will display in the measured volume field .
6. Press  to end the calibration.
7. Press  to get to the dispensed volume field , then press  to enter the field. Enter the amount of material in the cylinder.
8. After the volume is entered, the system calculates the new k-factor  and shows it on Setup Screen 4.
NOTE: To clear the counter and begin the calibration again, press , move briefly to another screen, then return to Setup Screen 4 and start over. If you press  without leaving the screen, the counter will continue from where it is, without clearing.
9. Press  to exit the screen.
10. Press  to exit Setup Mode.

Setting Modbus Address



See **Setup Screen 5**. By default, the Modbus is set to Off . If you need the Modbus, set the Modbus mode to SLAVE . The address value is between 1 and 247. The modbus address corresponds to the address of the Informer. See Appendix A for further information.

Update Software

Software updates are installed using a software token (PN 16P468), which is sent automatically when a new version of the software is released. Manual 3A1244 will accompany any necessary software updates. Follow all instructions and warnings in Manual 3A1244 to update your Informer software.

Replace Battery

Replace the battery only if the clock stops functioning after disconnecting power or a power failure.

				
<p>Sparking can occur when changing the battery. Replace the battery only in a non-hazardous location, away from flammable fluids or fumes.</p>				

NOTICE

To avoid damage to the circuit board, wear Part No. 112190 grounding strap, and ground appropriately.

1. Disconnect power.
2. Remove the Informer from the bracket.
3. Attach the grounding strap.
4. Remove 4 screws, and then remove the access cover.

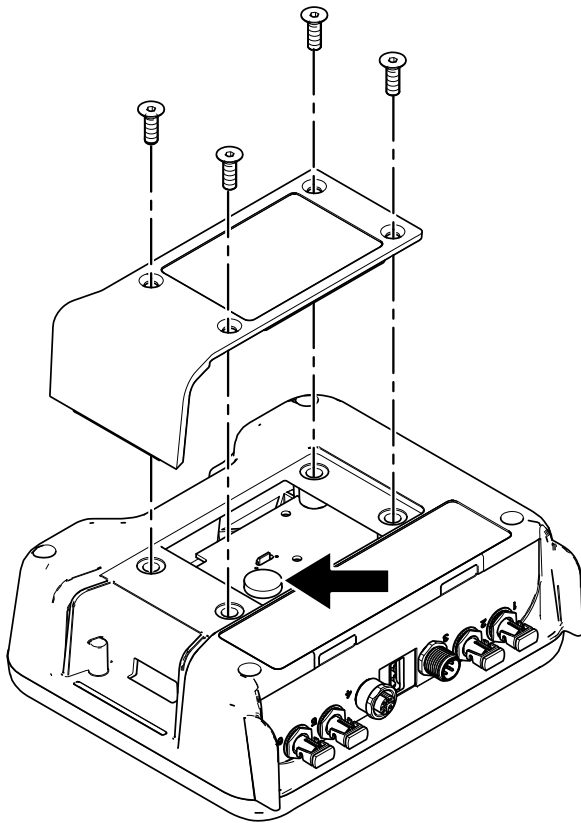

ti18949a

5. Use a flathead screwdriver to pry out the old battery.

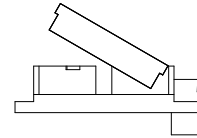

ti18947a

NOTE: Dispose of battery properly in an approved container and according to applicable local guidelines.

6. Replace with new battery. Ensure battery fits under connector tabs before snapping other end in place.

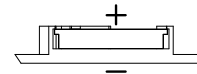

ti18948a

NOTE: Use only Panasonic CR2032 batteries for replacement.

7. Reassemble access cover and screws.
8. Snap the Informer back into the bracket.

Display Module

Display Information

The Display Module provides the interface for users to enter selections and view information related to setup and operation.

The screen backlight is factory set to remain on, even without screen activity. See **Setup Screen 3** to set the backlight timer to your preference. Press any key to restore.

Keys are used to input numerical data, enter setup screens, navigate within a screen, scroll through screens, and select setup values.

NOTICE

To prevent damage to the softkey buttons, do not press the buttons with sharp objects such as pens, plastic cards, or fingernails.

Operation Modes



The Informer has two operation modes: Run Mode and Setup Mode. For detailed information see [Run Screens, page 23](#), and [Setup Screens, page 25](#).

Press  to toggle between these two modes.

Screen Navigation and Editing

Refer to this section if you have questions about screen navigation or about how to enter information and make selections.





All Screens

1. Use   to move between screens.
2. Press  to enter a screen. The first data field on the screen will highlight.





3. Use   to highlight the data you wish to change.

4. Press  to edit.

Drop Down Field



1. Use   to highlight the correct choice from the dropdown menu.
2. Press  to select.
3. Press  to cancel.

Number Field

1. The first digit will be highlighted. Use   to change the number.
2. Press  to move to the next digit.
3. When all digits are correct, press  again to accept.
4. Press  to cancel.

Check Box Field



A check box field is used to enable or disable features in the software.

1. Press  to toggle between  and an empty box.
2. The feature is enabled if a  is in the box.

Reset Field

The reset field is used for totalizers. Press  to reset the field to zero.

When all data is correct, press  to exit the screen.







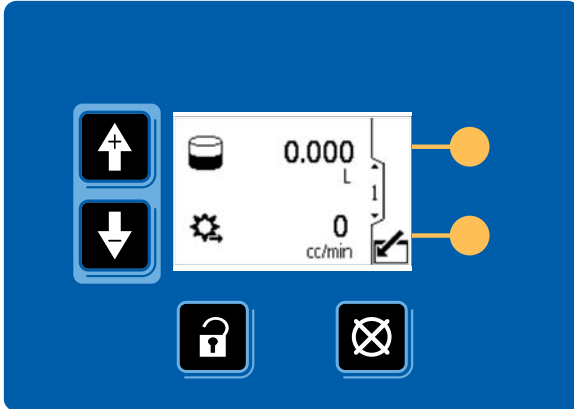



Then use   to move to a new screen, or  to move between Setup Mode and Run Mode.

Icons

As you move through the Informer screens, you will notice that most information is communicated using icons rather than words to simplify global communication. The detailed screen descriptions in [Run Screens, page 23](#), and [Setup Screens, page 25](#), explain what each icon represents. Icon reference tables also are provided, on this page and the next. Softkeys are membrane buttons whose function correlates with the screen content to the immediate left of the button.



ii17987a

Membrane Keys	Softkeys
 <p>Press to toggle between Run mode and Setup Mode.</p>	 <p><i>Enter Screen.</i> Highlight data that can be edited. Also changes the function of the Up/Down arrows so they move between data fields on the screen, rather than between screens.</p>
 <p><i>Error Reset:</i> Use to clear alarm after cause has been fixed. Also used to cancel data entered and return to original data.</p>	 <p><i>Exit Screen.</i> Exit data editing.</p>
 <p><i>Up/Down Arrows:</i> Use to move between screens or fields on a screen, or to increment or decrement the digits in a settable field.</p>	 <p><i>Enter.</i> Press to activate a field for editing or to accept the highlighted selection on a dropdown menu.</p>
 <p><i>Softkeys:</i> Use varies by screen. See columns at right.</p>	 <p><i>Right.</i> Move to the right when editing number fields. Press again to accept the entry when all digits are correct.</p>
	 <p><i>Reset.</i> Reset totalizer to zero.</p>
	 <p>Start</p>
	 <p>Stop</p>

Screen Icons	
Screen number. The arrows indicate more screens are available to view.	Lock icon indicates the unit is in Setup mode.
Batch Totalizer	Select Correct Date
Maintenance Totalizer	Flow Rate
Grand Totalizer	Enter User-Set Password
Set Maintenance Target	Set Batch/Maintenance Units
Set Grand Total Units	Set Modbus Mode
Set Modbus Address	Set Serial Port Baudrate

Screen Icons	
Set Serial Port Parity	Modbus Functionality is Off
Set Flow Rate Maximum and Minimum	Informer is Modbus Slave
Set Flow Rate Units	Maintenance Totalizer Alarm Enable
K-Factor	Flow Rate Alarm Enable
Volume measured by the meter	Alarm Auto Clear Enable (for accessories)
Actual volume dispensed	Select Date Format
Set the Correct Time	F3 Flow Rate High Alarm
MF Maintenance Alarm	F2 Flow Rate Low Alarm

Run Screens

When in Run Mode, the Informer displays the current flow rate and batch total on Screen 1. Screen 2 displays the grand total for the flow meter to which it is connected. Screens 3–6 display a log of the last 20 alarms.

Run Screen 1

Use this screen to view the current batch total and flow rate, or to reset the batch totalizer to 0. Units are set on Setup Screen 1 and Setup Screen 2.

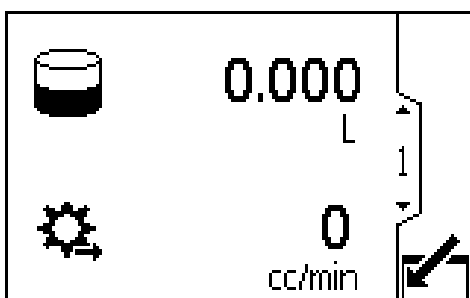

Figure 2 Run Screen 1

Key	
	Enter the screen.
	Batch Totalizer - Displays the amount of fluid measured since the last time the field was reset to zero.
	Flow Rate - Displays the current flow rate.
	Reset Batch Totalizer - resets the batch totalizer to zero.
	Move between Run Screens.

Run Screen 2

Use this screen to view the grand total flow for the system. The grand total cannot be reset.

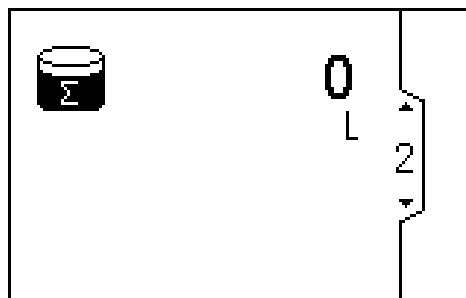

Figure 3 Run Screen 2

Key	
	Grand Totalizer - Displays the grand total flow for the system. This value cannot be reset.
	Move between Run Screens.

Run Screens 3 — 6

Use Screens 3 — 6 to view the log of recent alarms.

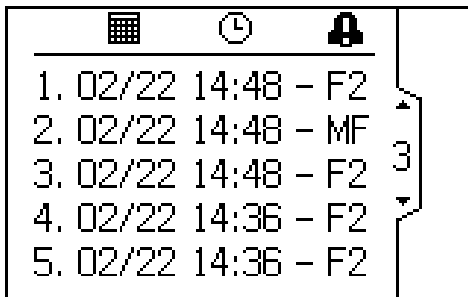







Figure 4 Run Screen 3

Key	
	Date on which the Deviation or Advisory Alarm occurred.
	Time at which the Deviation or Advisory Alarm occurred.
	General symbol indicating a deviation or advisory alarm. MF is the maintenance alarm. F2 is the flow rate low alarm. F3 is the flow rate high alarm. See Deviations and Advisories, page 29 for more information.
	Move between Run Screens.

Password Screen

If a password has been set, the Password Screen displays when  is pressed from any Run screen. Enter password to enable entry to the Setup screens. Set the password to 0000 to disable password protection. See Setup Screen 7 to set or change the password.

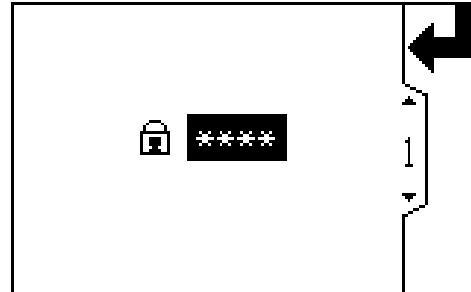





Figure 5 Password Screen

	Press to enter a password.
	Move to the right when editing number fields. Press again to accept the entry when all digits are correct.
	Enter the user-set password for the system.
	Increment/decrement the digits when editing number fields.

Setup Screens

The Setup Mode is used to set up a password (if desired) and to set parameters for monitoring fluid flow with the Informer. See [Screen Navigation and Editing, page 20](#), for information on how to make selections and enter data.

Setup Screen 1

Use this screen to view and reset the maintenance totalizer, set the maintenance target value, and set the batch and grand totalizer units shown on the Run Screens. Maintenance totalizer units, shown on this Setup Screen, are always cc.

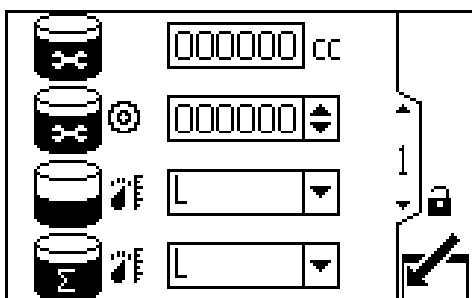

Figure 6 Setup Screen 1

Key	
	Enter the screen to set or change preferences.
	Press to activate a field for editing or to accept the highlighted selection on a dropdown menu.

	Move to the right when editing number fields. Press again to accept the entry when all digits are correct.
	Reset Maintenance Totalizer - resets the maintenance totalizer to zero.
	Maintenance Totalizer - Displays the current maintenance total in cubic centimeters.
	Set your desired maintenance total target value in this field in cubic centimeters. See Setup Screen 3 to set or disable the maintenance alarm.
	Batch Totalizer Units - Select from the following drop down options.
	cc Cubic centimeters
	L Liters
	Grand Totalizer Units - Select from the following drop down options.
	cc Cubic centimeters
	L Liters
	gal Gallons
	Exit data editing.
	Exit data editing.
	Move between Setup Screens, fields on a screen, or to increment/decrement the digits when editing number fields.

Setup Screen 2

Use this screen to set your flow rate maximum and minimum values and to select units for flow rate.

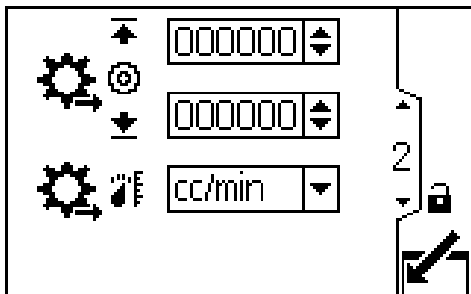

Figure 7 Setup Screen 2

Key	
	Enter the screen to set or change preferences.
	Press to activate a field for editing or to accept the highlighted selection on a dropdown menu.
	Move to the right when editing number fields. Press again to accept the entry when all digits are correct.
	Set your desired flow rate maximum (first data field) and minimum (second data field) threshold values. See Setup Screen 3 to set or disable the flow rate alarms.
	Flow Rate Units - Select from the following drop down options.
	cc/min Cubic centimeters per minute
	L/min Liters per minute
	gal/min Gallons per minute
	Exit data editing.
	Move between Setup Screens, fields on a screen, or to increment/decrement the digits when editing number fields.

Setup Screen 3

Use this screen to set your alarm preferences. Select to enable the alarm, or leave the box empty to disable the alarm.

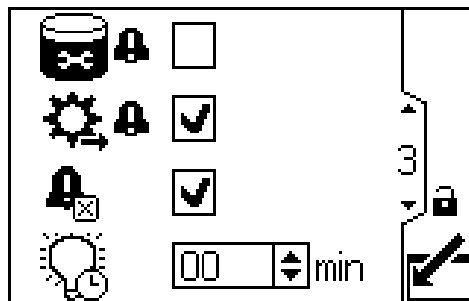

Figure 8 Setup Screen 3

Key	
	Enter the screen to set or change preferences.
	Press to toggle between <input checked="" type="checkbox"/> and blank.
	Maintenance Totalizer Alarm Enable
	Flow Rate Alarm Enable
	Alarm Auto Clear Enable. If enabled, when the flow rate returns to within the flow limit set points, the flow rate alarm will clear on any attached accessories, such as a the light tower. The alarm will still be displayed on the Informer screen.
	Set display backlight timer. Enter "00" to set the backlight to remain on.
	Exit data editing.
	Move between Setup Screens, fields on a screen, or to increment/decrement the digits when editing number fields.

Setup Screen 4

Use this screen to calibrate your meter and to view or set your meter k-factor. See [Meter Calibration, page 17](#), for procedure.

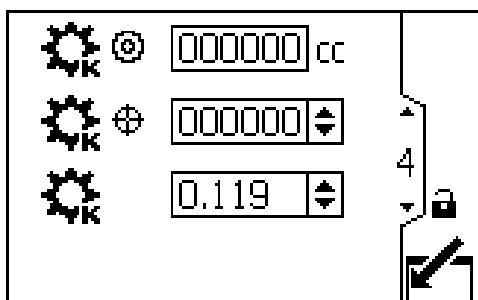

Figure 9 Setup Screen 4

Key	
	Enter the screen to set or change preferences.
	Press to activate a field for editing or to accept the highlighted selection on a dropdown menu.
	Move to the right when editing number fields. Press again to accept the entry when all digits are correct.
	Start the calibration.
	Stop the calibration.
	Displays the volume measured by the system for the calibration test.
	Enter the actual volume in the cylinder from the calibration test.
	Displays the meter k-factor. User can set the k-factor manually. The system automatically updates to the correct k-factor when the meter is calibrated.
	Exit data editing.
	Move between Setup Screens, fields on a screen, or to increment/decrement the digits when editing number fields.

Setup Screen 5

Use this screen to set your modbus preferences for ports 1 and 2. Note that ports 5 and 6 are used as modbus master devices for connecting to other Informer (or ProCrontol 1KE) modules.

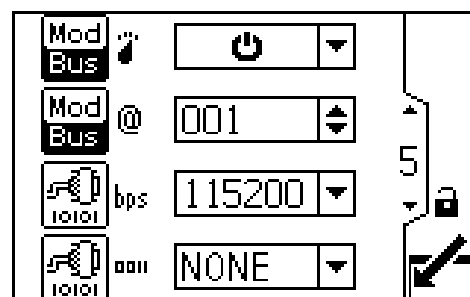

Figure 10 Setup Screen 5

Key	
	Modbus mode. Select off or Slave from the dropdown options.
	Turn off Modbus functionality if not used.
	Use Informer as Modbus slave device.
	Enter or change the Modbus address. Value is between 1 and 247.
	Select serial port baudrate from the dropdown options: 9600, 19200, 38400, 57600, or 115200.
	Select serial port parity from the dropdown options: NONE, ODD, or EVEN.,
	Exit data editing.
	Move between Setup Screens, fields on a screen, or to increment/decrement the digits when editing number fields.

Setup Screen 6

Use this screen to set your date format, date, and time.

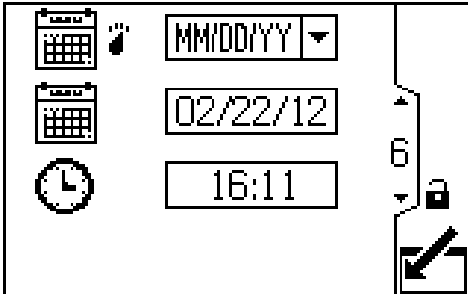

Figure 11 Setup Screen 6

Key	
	Enter the screen to set or change preferences.
	Press to activate a field for editing or to accept the highlighted selection on a dropdown menu.
	Move to the right when editing number fields. Press again to accept the entry when all digits are correct.
	Select your preferred date format from the dropdown menu.
	MM/DD/YY
	DD/MM/YY
	YY/MM/DD
	Set the current date.
	Set the current time.
	Exit data editing.
	Move between Setup Screens, fields on a screen, or to increment/decrement the digits when editing number fields.

Setup Screen 7

Use this screen to enter a password that will be required to access the Setup screens. This screen also displays the software version.

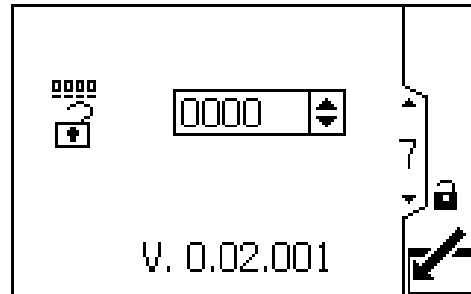

Figure 12 Setup Screen 7

Key	
	Enter the screen to set the password.
	Press to activate the field for editing.
	Move to the right when editing number fields. Press again to accept the entry when all digits are correct.
	Enter desired password. Enter "0000" to disable the password.
	Exit data editing.
	Move between Setup Screens, fields on a screen, or to increment/decrement the digits when editing number fields.

Deviations and Advisories

There are two types of errors that can occur. Errors are indicated on the display.

Deviations, indicated by , require attention, but not immediately.

Advisories, indicated by , do not require attention.







If a deviation or advisory occurs, the system continues running. The error code and the 

or the  flash on the screen. **If multiple alarms occur, F2 and F3 have higher priority than MF. They will appear first and must be cleared first.**

Alarm Log Logic: If Alarm Auto Clear is enabled, the system will not log the same alarm twice. For example, if the system fluctuates between low flow (F2) and acceptable flow, the system will log this error only once, to keep the log from filling up before the operator corrects the condition.

If Alarm Auto Clear is not enabled, each alarm will log only **once** if the operator corrects the condition **and then** clears the alarm. The alarm will log twice if the operator clears the alarm before correcting the condition.

The following table explains the error type that is associated with each error code and icon.

Deviations and Advisories		
Icon and Code	Description	How to Correct and Clear
 F2	Deviation alarm. If enabled, the flow rate low alarm displays when the flow rate is lower than the user set minimum.	Adjust flow rate, reset minimum flow target (see Setup Screen 2), or disable alarm (see Setup Screen 3). Press  to clear screen. The alarm will not clear if the flow rate is still lower than the user set target.
 F3	Deviation alarm. If enabled, the flow rate high alarm displays when the flow rate is higher than the user set maximum.	Adjust flow rate, reset maximum flow target (see Setup Screen 2), or disable alarm (see Setup Screen 3). Press  to clear alarm. The alarm will not clear if the flow rate is still higher than the user set target.
 MF	Advisory alarm. If enabled, the maintenance totalizer alarm displays when the user-set maintenance target value is reached.	Reset Maintenance Totalizer to zero (see Setup Screen 1). Perform maintenance. Press  to clear alarm. Alarm will not clear until Maintenance Totalizer has been reset to zero and no deviation alarms are occurring.

Troubleshooting

Problem	Cause	Solution
Informer is completely dark.	Power is not on.	Turn power supply on.
	Loose or disconnected power cable.	Tighten or connect cable.
Informer has power but does not function.	Hardware failure.	Replace Informer.
Flow Rate reads 0 when fluid is flowing.	Loose or disconnected flow meter cable.	Check the digital input/output cable going to/from the meter.
Inaccurate flow reading	Faulty flow meter sensor or meter.	Replace sensor or meter.
	Meter needs calibration.	Calibrate meter. See Meter Calibration, page 17 .
Display readout faulty.	Excessive static discharge.	Replace Informer.
	Ambient temperature too high.	Lower ambient temperature.
Communication failure	Incorrect data addresses.	Check address configuration.
	Incorrect communication parameters.	Check communication parameters.
	Incorrect cabling.	Check cabling and wiring. See Installation, page 8 .
Fluid is not flowing.	Clogs in fluid line or in meter.	Clean fluid line and/or meter. See meter manual.
	Gears worn or damaged.	Service meter. See meter manual.

Diagnostic Information

The LEDs on the bottom of the Informer give important information about system function.

LED Signals

Signal	Description
Green On	Informer is powered up.
Yellow	Internal communication in progress.
Red solid	Informer failure. See Troubleshooting.
Red flashing	Software is updating.
Red flashing slowly	Token error; remove token and upload software token again.

Parts

Kits for Hazardous Location, 24L074, 24L077, and 24L078

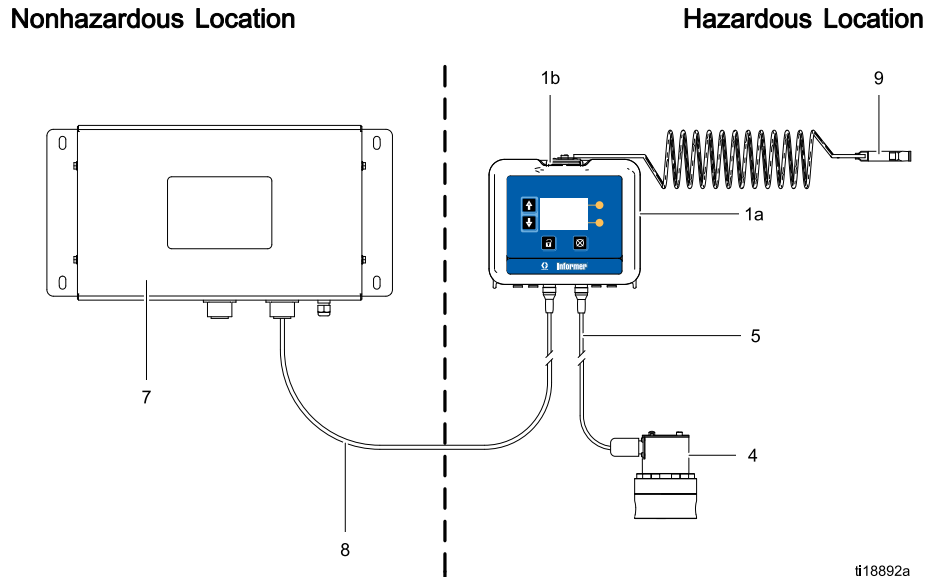

li18892a

Kits 24L074, 24L077, and 24L078

Ref.	Part	Description	24L074	24L077	24L078	Qty.
1	24L073	MODULE, Informer, includes 1a-1c	✓	✓	✓	1
1a	N/A	MODULE, Informer, with software				
1b	277853	BRACKET				
1c▲	16P265	LABEL, warning, not shown				
4	289813	METER, G3000	✓		✓	1
5	16V074	CABLE, intrinsically safe*, meter, 16 m (52.5 ft.)	✓		✓	1
7	16M167	POWER SUPPLY, 90–264 VAC input, 15 VDC output. <i>See Manual 332196.</i>		✓	✓	1
8	16K509	CABLE, power, intrinsically safe*, 50 ft. (15 m)		✓	✓	1
9	244524	GROUND WIRE, assembly with clamp	✓	✓	✓	1

* Intrinsically safe cables are identified by the blue tags installed on the cables.

▲ Replacement Danger and Warning labels, tags, and cards are available at no cost.

Kits for Non-Hazardous Location, 24L075 and 24L076

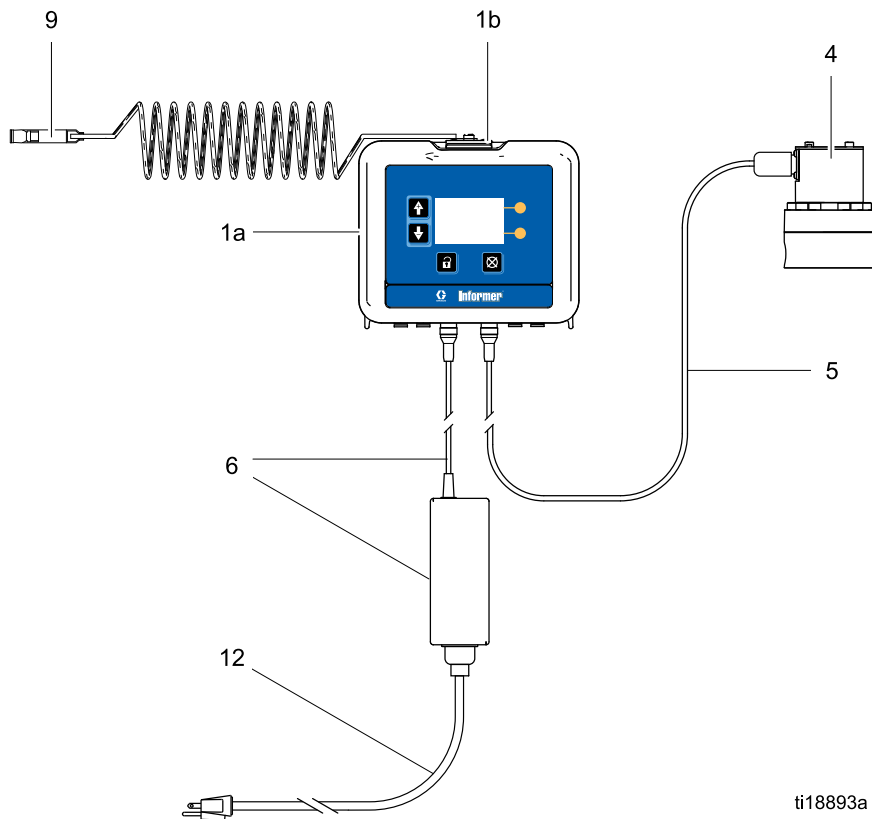



ti18893a

Ref.	Part	Description	24L075	24L076	Qty.
1	24L073	MODULE, Informer, includes 1a-1c	✓	✓	1
1a	N/A	MODULE, Informer, with software			
1b	277853	BRACKET			
1c▲	16P265	LABEL, warning, not shown			
4	289813	METER, G3000		✓	1
5	16K483	CABLE, meter, 16 M (52.5 ft.)		✓	1
6	16V680	POWER SUPPLY, 90–264 VAC input, 15 VDC output	✓	✓	1
9	244524	GROUND WIRE, assembly with clamp	✓	✓	1
12	245202	CORD, set, 10 ft (3 m), 120V SJT North American style plug, IEC 320–C13 female connector	✓	✓	1

▲ Replacement Danger and Warning labels, tags, and cards are available at no cost.

Accessories

					
Not all accessories and kits are approved for use in hazardous locations. Refer to the specific accessory and kit manuals for approval details.					

Accessories for Hazardous Locations

Part No.	Description
16K615	Power Cable, 100 ft (30 m), for power supply.
16K509	Power Cable, 50 ft (15 m), for power supply.
16M172	Fiber Optic Cable, 50 ft (15 m).
16M173	Fiber Optic Cable, 100 ft (30 m).
289814	G3000HR Meter, Positive displacement, gear flow meter, 0.01 to 0.5 gpm (38 to 1900 cc/min.), for low to medium viscosity materials.
280560	HG6000 Meter, Positive displacement, helical gear flow meter, 0.013 to 6.0 gpm (50 to 22,712 cc/min.), for high flow, high viscosity materials.
258718	S3000 Solvent Meter, Positive displacement, gear flow meter, 0.01 to 0.5 gpm (38 to 1900 cc/min.), for light viscosity materials.
24N525	Coriolis Meter, Non-intrusive mass flow meter, for abrasive and filled materials, range of flow rates and materials.
24C471	Fluid Regulator, 1:2, low flow.
24C472	Fluid Regulator, 1:3, low flow.

Accessories for Non-Hazardous Location

Part No.	Description
16P467	Power Barrier Kit, includes power barrier, terminal blocks, wiring, and power cable. Add to the power supply to power an additional ProControl 1KE (or Informer).
16K484	Cable Extension, 50 ft (15 m), for meter.
24N977	Modbus Gateway Kit, use to communicate with a PLC. Also used together with the AWI Module (Graco PN 15V337), to enable communication with a PC via ethernet.
24N978	Fiber Optic to Serial Converter Kit, use to communicate with a PLC via a serial cable.
15V337	Advanced Web Interface Module (AWI), use to communicate from the Informer to a PLC via ethernet. A Modbus Gateway Kit, Graco PN 24N977, sold separately, also is required..
24N807	Light Tower Kit, includes tower and splitter cable.
24P006	Digital IO Accessory Cable Kit, includes cable and splitter cable for connecting a light tower or other accessory to the ProControl 1KE system.

Mounting Dimensions

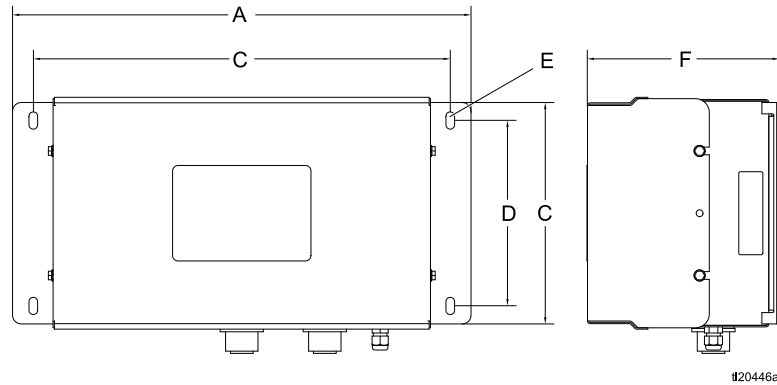

Figure 13 Power Supply

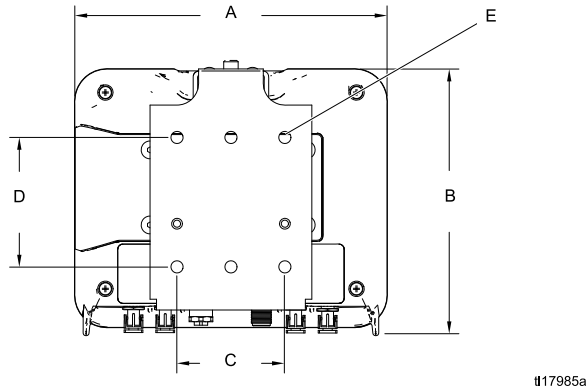

Figure 14 Informer Module

Component	A Overall Width in. (mm)	B Overall Height in. (mm)	Overall Depth in. (mm)	Mounting Dimensions Width (C) x Height (D) in. (mm)	E Mounting Hole Size in. (mm)
Power Supply 16M167	16.6 (420.9)	8.7 (221.2)	4.5 (114.8)	15.1 x 6.7 (382.8 x 170.2)	0.31 (7.9)
Informer	7.2 (183)	6.0 (152)	2.8 (71)	2.5 x 3.0 (64 x 76)	0.28 (7)

Appendix A - Modbus Variable Map

Table 1 Device Identification Registers

Register Permissions	Informer Modbus Register	Description	Size	Units
Read Only	401040	Software Version Major	32 Bit	
Read Only	401042	Software Version Minor	32 Bit	
Read Only	401044	Software Version Build	32 Bit	
Read Only	401072	Serial Number String - Bytes 0-3	32 Bit	String, 4 Bytes
Read Only	401074	Serial Number String - Bytes 4-7	32 Bit	String, 4 Bytes
Read Only	401076	Serial Number String - Bytes 8-11	32 Bit	String, 4 Bytes
Read Only	401078	Serial Number String - Bytes 12-15	32 Bit	String, 4 Bytes
Read Only	401080	Serial Number String - Bytes 16-19	32 Bit	String, 4 Bytes
Read Only	401082	Serial Number String - Bytes 20-23	32 Bit	String, 4 Bytes
Read Only	401084	Serial Number String - Bytes 24-27	32 Bit	String, 4 Bytes
Read Only	401086	Serial Number String - Bytes 28-31	32 Bit	String, 4 Bytes

Table 2 Run Registers

Register Permissions	Informer Modbus Register	Description	Size	Units	Low Limit	High Limit	Notes
Read/Write	402000	Date, Year	16 Bit	YY	1	99	
Read/Write	402001	Date, Month	16 Bit	MM	1	12	
Read/Write	402002	Date, Day	16 Bit	DD	1	31	
Read/Write	402003	Time, Hour	16 Bit	HH	0	23	
Read/Write	402004	Time, Minute	16 Bit	MM	0	60	
Read/Write	402005	Time, Second	16 Bit	SS	0	60	
Read/Write	402006	Alarms Needing Acknowledgment	32 Bit	Bit-field alarms	0	0	0b0001–high flow alarm; 0b0010 — low flow alarm; 0b0100–main-tenance target — set bit to 0 to reset
Read Only	402008	Current Grand Total	32 Bit	cc	0	32-bit	
Read/Write	402010	Current Batch Total	32 Bit	cc	0	999999	Write 0 to reset
Read/Write	402012	Current Maintenance Total	32 Bit	cc	0	999999	Write 0 to reset
Read Only	402014	Current Flow Rate	32 Bit	cc/min	0	65536	
Read/Write	402016	Calibration Mode	16 Bit	0-off, 1=on	0	1	

Appendix A - Modbus Variable Map

Read/Write	402017	Calibration, Measured Volume	32 Bit	pulses	0	32-bit	
Read/Write	402019	Calibration, Actual Dispensed Volume	32 Bit	cc	0	32-bit	

Table 3 Setup Registers

Register Permissions	Informer Modbus Register	Description	Size	Units	Low Limit	High Limit	Notes
Read/Write	403000	Communication, Modbus Mode	16 Bit	0=off, 1=on	0	1	
Read/Write	403001	Communication, Modbus Address	32 Bit	1-247	1	247	
Read/Write	403003	Communication, Modbus Baud Rate	16 Bit	0=9600, 1=19200, 2=38400, 3=578600, 4=115200	0	4	
Read/Write	403004	Communication, Modbus Parity	16 Bit	0=None, 1=Odd, 2=Even	0	2	
Read/Write	403005	Communication, Modbus StopBits	16 Bit	none	1	2	
Read/Write	403006	Display, Date Format	16 Bit	0=mm/dd/yy, 1=dd/mm/yy, 2=yy/mm/dd	0	2	
Read/Write	403007	Display, Backlight Timer	16 Bit	min	0	99	
Read/Write	403008	Display, Maintenance Totalizer Alarm Enable	16 Bit	0=off, 1=on	0	1	
Read/Write	403009	Display, Flow Rate Alarm Enable	16 Bit	0=off, 1=on	0	1	
Read/Write	403010	Display, Alarm Auto Clear	16 Bit	0=off, 1=on	0	1	
Read/Write	403012	Units, Flow Rate	16 Bit	0=cc/min, 1=l/min, 2=gal/min	0	2	
Read/Write	403013	Units, Batch Volume	16 Bit	0=cc, 1=l, 2=gal	0	2	
Read/Write	403014	Units, Grand Volume	16 Bit	0=cc, 1=l, 2=gal	0	2	
Read/Write	403015	System, Maintenance Target	32 Bit	cc	0	999999	
Read/Write	403017	System, Flow Rate Maximum	32 Bit	cc	0	999000	
Read/Write	403019	System, Flow Rate Minimum	32 Bit	cc	0	999000	
Read/Write	403021	System, Meter K-Factor	16 Bit	cc	10	5000	(/ 1000)

Appendix B - Advanced Web Interface

Overview

The Advanced Web Interface (AWI) is Graco PN 15V337. It is an accessory that works with many Graco devices to enable communication with a PC via ethernet. The kit includes Manual 332459, which contains installation and setup information common to all devices. It includes sections on how to configure your computer, initialize the system, configure the main system settings, and set up your network. Refer to Manual 332459 first, then return to this Appendix for information specific to the Informer.

NOTE: A modbus gateway (Graco PN 24N977, sold separately) and a Fiber Optic to Serial Converter (Graco PN 24N978, sold separately) are required to enable the Informer to communicate with the AWI.

NOTE: The AWI must be version 3.01.001 or greater.

Network Tab

When you have finished setting up the system as directed in Manual 332459, select the **Network Tab**. It should show at least one Informer on the list of networked devices. Click on the icon for the Informer you desire.

NOTE: If you still need to search for or manually add Informers, see the Network Tab instructions in Manual 332459.

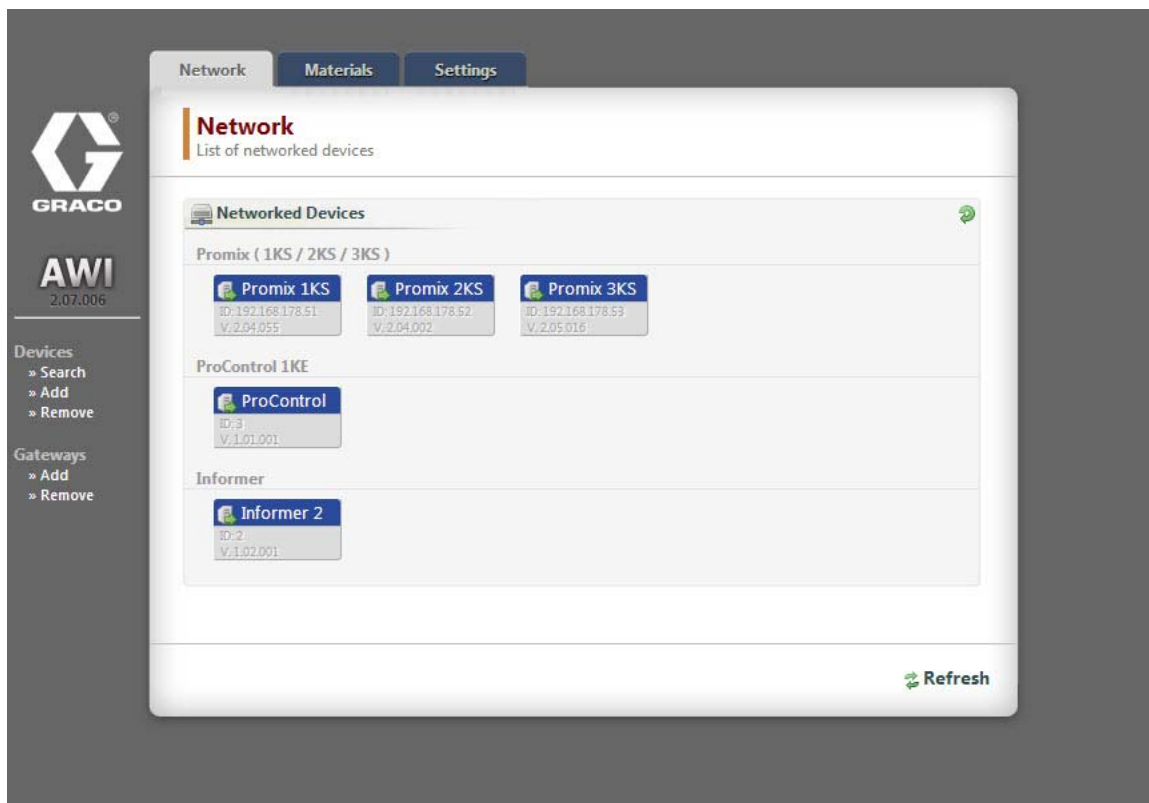

Monitor Tab

Use this tab to monitor the current device in real time. The only change that can be made on this tab is to reset the batch total. Click **Reset** to change the batch total immediately to zero.

The screenshot displays the 'Monitor' tab of a web interface. On the left sidebar, there is a navigation menu with a 'Monitor' tab selected. Below the menu is a small device image and the text 'INF2 V. 1.02.001 ID: 2'. The main content area is titled 'Monitor' and includes the instruction 'Monitor current device in real time'. It features three summary cards: 'Flow Rate' (99 CC/MIN), 'Batch Total' (5069 CC) with a 'Reset' button, and 'Grand Total' (1004969 CC). To the right is an 'Event Log' table with the following data:

#	Date	Time	Event Code	Event Type
1	13/5/24	12:4	MF	1
2	13/5/16	10:53	F2	2

Setup Tab

Click on **Setup**. Use this tab to view or change your Informer settings. For items with a field, type the desired number in the field and press **Enter** on your keyboard. The change takes place when you press

Enter. For drop-down menus, click on the desired option. The change is immediate.

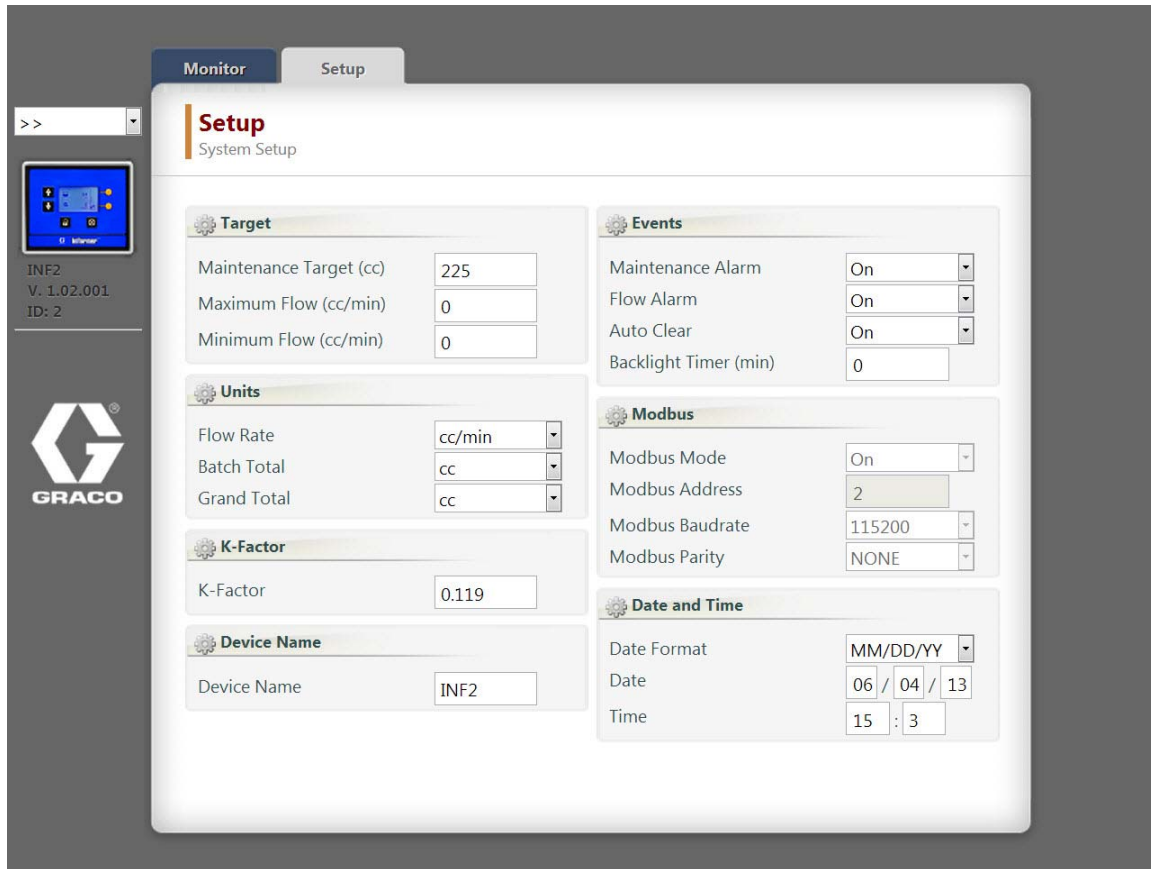

Target

In this screen section, view or adjust your maintenance target, maximum flow rate target, and minimum flow rate target. Type the desired number in the field.

Target	
Maintenance Target (cc)	225
Maximum Flow (cc/min)	0
Minimum Flow (cc/min)	0

Units

In this screen section, view or adjust the desired units for flow rate, batch total, and grand total. Use the dropdown menu for each to select different units, if desired.

Units	
Flow Rate	cc/min
Batch Total	cc
Grand Total	cc

K-Factor

In this screen section, view or adjust the k-factor for the system's meter. See [Meter Calibration, page 17](#).

K-Factor	
K-Factor	<input type="text" value="0.119"/>

Device Name

In this screen section, type a name in the field to help you differentiate Informers, if you are using more than one.

Device Name	
Device Name	<input type="text" value="Informer 2"/>

Events

In this screen section, view or adjust the alarm settings and backlight timer. Use the dropdown menus to toggle between **On** and **Off** for the maintenance alarm, flow alarm, and auto clear. For the backlight timer, type a number in the field to correspond to the number of minutes the display can be idle before it turns off the backlight to save power.

Events	
Maintenance Alarm	<input type="text" value="Off"/>
Flow Alarm	<input type="text" value="Off"/>
Auto Clear	<input type="text" value="Off"/>
Backlight Timer (min)	<input type="text" value="0"/>

Modbus

In this screen section, view the modbus mode, address, baud rate, and parity. Modbus information must be adjusted on the Informer. If you were to adjust it on your PC, the change would cause a disruption in your connection.

Modbus	
Modbus Mode	<input type="text" value="On"/>
Modbus Address	<input type="text" value="2"/>
Modbus Baudrate	<input type="text" value="115200"/>
Modbus Parity	<input type="text" value="NONE"/>

Date and Time

In this screen section, view or adjust the date format, date, or time. Use the dropdown menu to select a new date format, if desired. For date and time, type the correct information in the field.

Date and Time	
Date Format	<input type="text" value="MM/DD/YY"/>
Date	<input type="text" value="05"/> / <input type="text" value="16"/> / <input type="text" value="13"/>
Time	<input type="text" value="9"/> : <input type="text" value="1"/>

Technical Data

Informer	US	Metric
Power In Requirements:		
Voltage:	90-264 VAC	
Frequency:	50-60 Hz	
Phase:	1	
Amps:	1.25A maximum	
Power Out Requirements:		
Power Supply 16V680	15 VDC, 1.2 A maximum	
Power Supply 16M167	15 VDC, 160 mA maximum	
Maximum Fluid Working Pressure		
289813 G3000 Meter	4000 psi	28 MPa, 276 bar
Environmental		
Operating Temperature	32°-122°F	0°-50°C
Storage Temperature	-22°-140°F	-30°-60°C
Humidity	0 to 95 percent, non-condensing	
Display housing is solvent resistant.		
Wetted Parts		
See the G3000 meter manual (308778) or Coriolis meter manual (313599).		
Weight		
Informer	1 lb	0.45 kg
Mounting Bracket	1 lb	0.45 kg
Power Supply 16M167	9 lb	4.1 kg
G3000 Meter	6	2.7 kg

Graco Standard Warranty

Graco warrants all equipment referenced in this document which is manufactured by Graco and bearing its name to be free from defects in material and workmanship on the date of sale to the original purchaser for use. With the exception of any special, extended, or limited warranty published by Graco, Graco will, for a period of twelve months from the date of sale, repair or replace any part of the equipment determined by Graco to be defective. This warranty applies only when the equipment is installed, operated and maintained in accordance with Graco's written recommendations.

This warranty does not cover, and Graco shall not be liable for general wear and tear, or any malfunction, damage or wear caused by faulty installation, misapplication, abrasion, corrosion, inadequate or improper maintenance, negligence, accident, tampering, or substitution of non-Graco component parts. Nor shall Graco be liable for malfunction, damage or wear caused by the incompatibility of Graco equipment with structures, accessories, equipment or materials not supplied by Graco, or the improper design, manufacture, installation, operation or maintenance of structures, accessories, equipment or materials not supplied by Graco.

This warranty is conditioned upon the prepaid return of the equipment claimed to be defective to an authorized Graco distributor for verification of the claimed defect. If the claimed defect is verified, Graco will repair or replace free of charge any defective parts. The equipment will be returned to the original purchaser transportation prepaid. If inspection of the equipment does not disclose any defect in material or workmanship, repairs will be made at a reasonable charge, which charges may include the costs of parts, labor, and transportation.

THIS WARRANTY IS EXCLUSIVE, AND IS IN LIEU OF ANY OTHER WARRANTIES, EXPRESS OR IMPLIED, INCLUDING BUT NOT LIMITED TO WARRANTY OF MERCHANTABILITY OR WARRANTY OF FITNESS FOR A PARTICULAR PURPOSE.

Graco's sole obligation and buyer's sole remedy for any breach of warranty shall be as set forth above. The buyer agrees that no other remedy (including, but not limited to, incidental or consequential damages for lost profits, lost sales, injury to person or property, or any other incidental or consequential loss) shall be available. Any action for breach of warranty must be brought within two (2) years of the date of sale.

GRACO MAKES NO WARRANTY, AND DISCLAIMS ALL IMPLIED WARRANTIES OF MERCHANTABILITY AND FITNESS FOR A PARTICULAR PURPOSE, IN CONNECTION WITH ACCESSORIES, EQUIPMENT, MATERIALS OR COMPONENTS SOLD BUT NOT MANUFACTURED BY GRACO. These items sold, but not manufactured by Graco (such as electric motors, switches, hose, etc.), are subject to the warranty, if any, of their manufacturer. Graco will provide purchaser with reasonable assistance in making any claim for breach of these warranties.

In no event will Graco be liable for indirect, incidental, special or consequential damages resulting from Graco supplying equipment hereunder, or the furnishing, performance, or use of any products or other goods sold hereto, whether due to a breach of contract, breach of warranty, the negligence of Graco, or otherwise.

FOR GRACO CANADA CUSTOMERS

The Parties acknowledge that they have required that the present document, as well as all documents, notices and legal proceedings entered into, given or instituted pursuant hereto or relating directly or indirectly hereto, be drawn up in English. Les parties reconnaissent avoir convenu que la rédaction du présente document sera en Anglais, ainsi que tous documents, avis et procédures judiciaires exécutés, donnés ou intentés, à la suite de ou en rapport, directement ou indirectement, avec les procédures concernées.

Graco Information

For the latest information about Graco products, visit www.graco.com.
For patent information, see www.graco.com/patents.

To place an order, contact your Graco Distributor or call to identify the nearest distributor.

Phone: 612-623-6921 **or Toll Free:** 1-800-328-0211 **Fax:** 612-378-3505

All written and visual data contained in this document reflects the latest product information available at the time of publication.

Graco reserves the right to make changes at any time without notice. Original Instructions.

This manual contains English. MM 3A2040

Graco Headquarters: Minneapolis
International Offices: Belgium, China, Japan, Korea

GRACO INC. AND SUBSIDIARIES • P.O. BOX 1441 • MINNEAPOLIS MN 55440-1441 • USA
Copyright 2012, Graco Inc. All Graco manufacturing locations are registered to ISO 9001.

www.graco.com
Revision E, March 2014