

Binks Model 95 SPRAY GUN 6121-XXXX-X

Model 95 Signature Series Spray Gun

This handheld gun is the premier spray gun in the Binks line. A combination of the three best industrial spray guns, Model 95 sets a new standard.

The Model 95 is a high production gun with stainless steel fluid passages which may be used with most coatings. This new gun replaces Models 18, 62 and BBR spray guns, incorporating the best features of all three: drop-forged anodized aluminum body, stainless steel fluid passages, adjustable floating needle valve, stainless steel or tungsten carbide fluid nozzle, plated drop-forged brass self-centering air nozzle, brass air valve cartridge, adjustable spray pattern, 3/8" NPS(m) fluid inlet, 1/4" NPS(m) air inlet. Weight 1 lb., 11 oz.

TYPES OF INSTALLATION

SIPHON FEED CUP HOOKUP

Air pressure for atomization is regulated at extractor. The amount of fluid is adjusted by fluid control screw on gun, viscosity of paint, and air pressure (see figure 1).

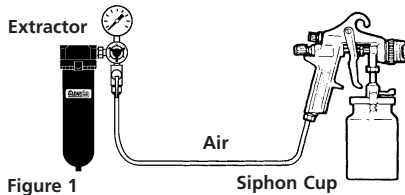

PRESSURE FEED CUP HOOKUP

For fine finishing with limited spraying.

Air pressure for atomization is regulated at extractor; fluid pressure at cup regulator. For heavy fluids and internal mix nozzle spraying, fluid adjusted by control screw on gun.

Pressure cup also available less regulator (see figure 2).

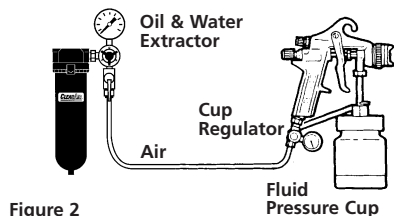

Illustration Key

1. Air Nozzle Assembly
2. Gun Body
3. Side Port Controls
4. Fluid Control Knob
5. Air Connection 1/4" NPS(m)
6. Fluid Connection 3/8" NPS(m)

PRESSURE FEED TANK HOOKUP

For medium production spraying (single regulator).

Air pressure for atomization is regulated at extractor, fluid pressure at tank regulator (see figure 3).

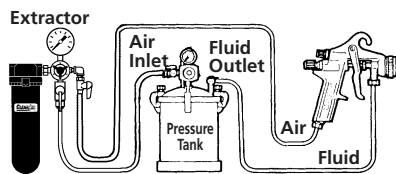

Figure 3

PRESSURE FEED TANK HOOKUP

For portable painting operations (double regulator).

Air pressure for atomization and fluid supply is regulated by two individual air regulators on tank (see figure 4).

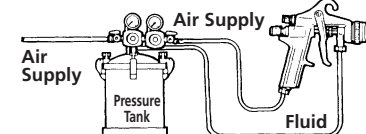

Figure 4

PRESSURE FEED CIRCULATING HOOKUP

For heavy production spraying.

Air pressure atomization regulated at extractor. Fluid pressure regulated at fluid regulator (see figure 5).

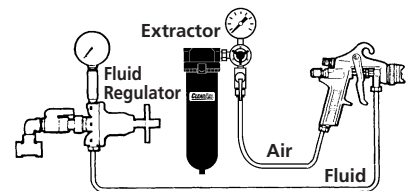

Figure 5

In this part sheet, the words **WARNING**, **CAUTION** and **NOTE** are used to emphasize important safety information as follows:

⚠ WARNING
 Hazards or unsafe practices which could result in severe personal injury, death or substantial property damage.

⚠ CAUTION
 Hazards or unsafe practices which could result in minor personal injury, product or property damage.

NOTE
 Important installation, operation or maintenance information.

⚠ WARNING

Read the following warnings before using this equipment.



READ THE MANUAL
 Before operating finishing equipment, read and understand all safety, operation and maintenance information provided in the operation manual.



WEAR SAFETY GLASSES
 Failure to wear safety glasses with side shields could result in serious eye injury or blindness.



DE-ENERGIZE, DEPRESSURIZE, DISCONNECT AND LOCK OUT ALL POWER SOURCES DURING MAINTENANCE
 Failure to De-energize, disconnect and lock out all power supplies before performing equipment maintenance could cause serious injury or death.



OPERATOR TRAINING
 All personnel must be trained before operating finishing equipment.



EQUIPMENT MISUSE HAZARD
 Equipment misuse can cause the equipment to rupture, malfunction, or start unexpectedly and result in serious injury.

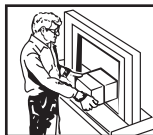

KEEP EQUIPMENT GUARDS IN PLACE
 Do not operate the equipment if the safety devices have been removed.

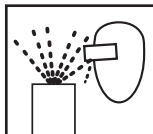

PROJECTILE HAZARD
 You may be injured by venting liquids or gases that are released under pressure, or flying debris.



PINCH POINT HAZARD
 Moving parts can crush and cut. Pinch points are basically any areas where there are moving parts.



AUTOMATIC EQUIPMENT
 Automatic equipment may start suddenly without warning.



INSPECT THE EQUIPMENT DAILY
 Inspect the equipment for worn or broken parts on a daily basis. Do not operate the equipment if you are uncertain about its condition.



NEVER MODIFY THE EQUIPMENT
 Do not modify the equipment unless the manufacturer provides written approval.



KNOW WHERE AND HOW TO SHUT OFF THE EQUIPMENT IN CASE OF AN EMERGENCY



PRESSURE RELIEF PROCEDURE
 Always follow the pressure relief procedure in the equipment instruction manual.



NOISE HAZARD
 You may be injured by loud noise. Hearing protection may be required when using this equipment.



STATIC CHARGE
 Fluid may develop a static charge that must be dissipated through proper grounding of the equipment, objects to be sprayed and all other electrically conductive objects in the dispensing area. Improper grounding or sparks can cause a hazardous condition and result in fire, explosion or electric shock and other serious injury.



FIRE AND EXPLOSION HAZARD
 Never use 1,1,1-trichloroethane, methylene chloride, other halogenated hydrocarbon solvents or fluids containing such solvents in equipment with aluminum wetted parts. Such use could result in a serious chemical reaction, with the possibility of explosion. Consult your fluid suppliers to ensure that the fluids being used are compatible with aluminum parts.



TOXIC FLUID & FUMES
 Hazardous fluid or toxic fumes can cause serious injury or death if splashed in the eyes or on the skin, inhaled, injected or swallowed. **LEARN** and **KNOW** the specific hazards of the fluids you are using.



WEAR RESPIRATOR
 Toxic fumes can cause serious injury or death if inhaled. Wear a respirator as recommended by the fluid and solvent manufacturer's Material Safety Data Sheet.



PROP 65 WARNING
WARNING: This product contains chemicals known to the State of California to cause cancer and birth defects or other reproductive harm.

IT IS THE RESPONSIBILITY OF THE EMPLOYER TO PROVIDE THIS INFORMATION TO THE OPERATOR OF THE EQUIPMENT.

FOR FURTHER SAFETY INFORMATION REGARDING BINKS AND DEVILBISS EQUIPMENT, SEE THE GENERAL EQUIPMENT SAFETY BOOKLET (77-5300).

AIR PRESSURE

Atomizing pressure must be set properly to allow for the drop in air pressure between the regulator and the spray gun.

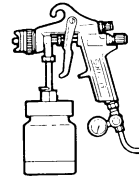
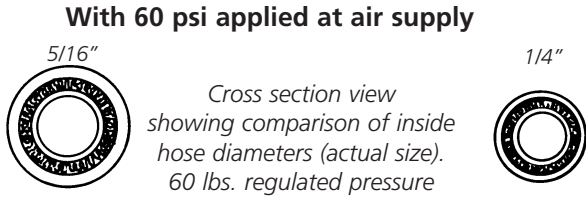

Only 34 PSI at gun inlet
25 feet of 1/4" I.D. hose causes a drop of 26 PSI between the air supply and the gun.
(NOT RECOMMENDED)

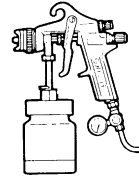

48 PSI at gun inlet
25 feet of 5/16" I.D. hose causes a drop of 12 PSI between the air supply and the gun. For this reason Binks recommends the use of 5/16" hose.
(RECOMMENDED)

BINKS OIL AND WATER EXTRACTOR IS IMPORTANT

Achieving a fine spray finish without the use of a good oil and water extractor is virtually impossible.

A Binks regulator / extractor serves a double purpose. It eliminates blistering and spotting by keeping air free of oil and water, and it gives precise air pressure control at the gun.

Binks recommends using Model HFRL-508 Oil and Water Extractor / Regulator. See your local distributor for other models.

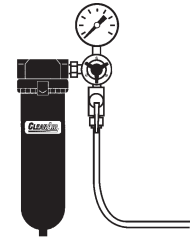

GUN HANDLING

The first requirement for a good resultant finish is the proper handling of the gun. The gun should be held perpendicular to the surface being covered and moved parallel with it. The stroke should be started before the trigger is pulled and the trigger should be released before the stroke is ended. This gives accurate control of the gun and material.

The distance between gun and surface should be 6 to 12 inches depending on material and atomizing pressure. The material deposited should always be even and wet. Lap each stroke over the preceding stroke to obtain a uniform finish.

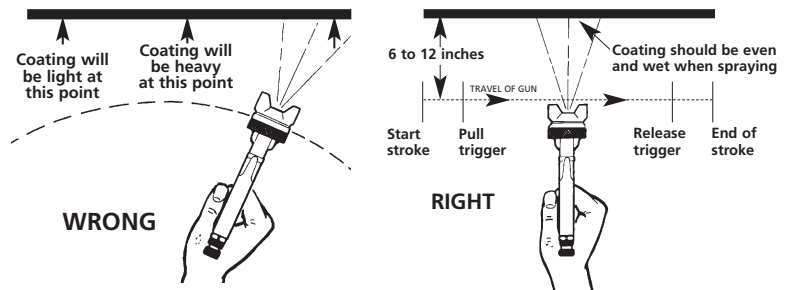

NOTE

To reduce overspray and obtain maximum efficiency, always spray with the lowest possible atomizing air pressure.

It is extremely poor practice to mount the oil and water extractor on or even near the compressor unit. The temperature of the air is greatly increased as it passes through the compressor and this compressed air must be cooled before the moisture in it will condense. If the air from the compressor is still warm when it passes through the oil and water extractor, moisture will not be effectively removed, but will remain in suspension. Then, when the air cools in the hose beyond the extractor, the moisture will condense into drops of water and cause trouble.

Air lines must be properly drained

Pitch all air lines back towards the compressor so that condensed moisture will flow back into the air receiver where it can be removed by opening a drain. Every low point on an air line acts as a water trap. Such points should be fitted with an easily accessible drain. See diagram.

AIR SUPPLY

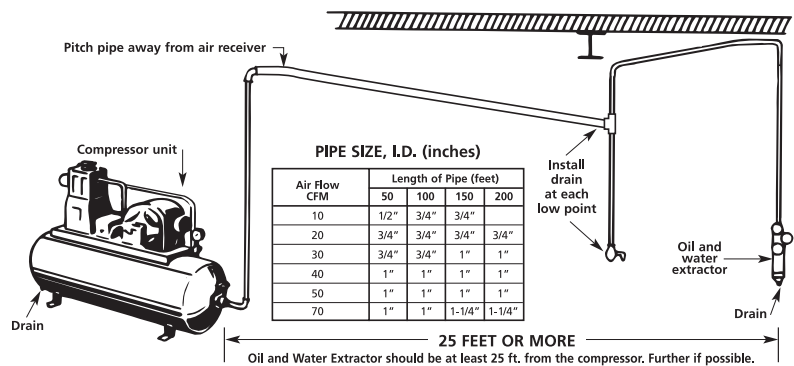

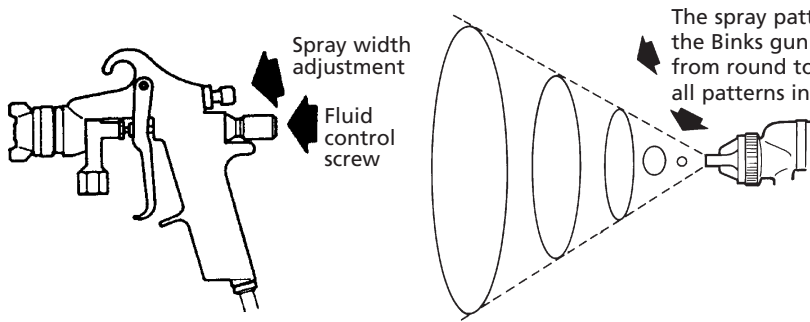

The spray pattern of the Binks gun is variable from round to flat with all patterns in between.

In normal operation, the wings on the nozzle are horizontal as illustrated here. This provides a vertical fan shaped pattern which

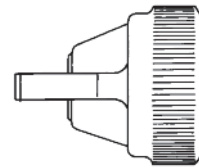

gives maximum coverage as the gun is moved back and forth parallel to the surface being finished.

Spray width adjustment: Turn clockwise for round, counterclockwise for fan.

Fluid control screw: Turn clockwise to decrease flow, counterclockwise to increase flow.

As width of spray is increased, more material must be allowed to pass through the gun to obtain the same coverage on the increased area.



SIPHON SPRAYING

Set atomization pressure at approximately 50 PSI for lacquer and 60 PSI for enamel. Test spray. If the spray is too fine, reduce the air pressure or open fluid control screw. If the spray is too coarse, close the fluid control screw. Adjust the pattern width and repeat adjustment of spray if necessary.

PRESSURE SPRAYING

After selecting correct size fluid orifice, set fluid pressure for desired flow. Open atomization air and test spray. If spray is too fine, reduce air pressure. If spray is too coarse, raise air pressure. Adjust pattern width and repeat adjustment of spray. Keeping fluid control screw in open position will reduce fluid needle wear.

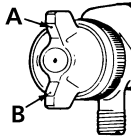
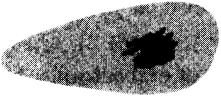
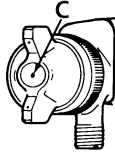
FAULTY PATTERNS AND HOW TO CORRECT THEM

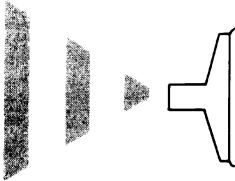
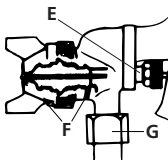
PATTERN	CAUSE	CORRECTION
	Dried material in side-port "A" restricts passage of air. Greater flow of air from cleaner side-port "B" forces fan pattern in direction of clogged side. 	Dissolve material in side-ports with thinner, then blow gun clean. Do not poke into openings with metal instruments.
	Dried material around the outside of the fluid nozzle tip at position "C" restricts the passage of atomizing air at one point through the center opening of air nozzle and results in pattern shown. This pattern can also be caused by a loose air nozzle. 	Remove air nozzle and wipe off fluid tip using rag wet with thinner. Tighten air nozzle.
	A split spray or one that is heavy on each end of a fan pattern and weak in the middle is usually caused by: (1) Too high an atomization air pressure (2) Attempting to get too wide a spray pattern with thin material.	Reducing air pressure will correct cause (1). To correct cause (2), open material control to full position by turning to left. At the same time, turn spray width adjustment to right. This will reduce width of spray, but will correct split spray pattern.
	(1) Dried out packing around material needle valve permits air to get into fluid passageway. This results in spitting. (2) Dirt between fluid nozzle seat and body or loosely installed fluid nozzle will make gun spit. (3) A loose or defective swivel nut on siphon cup or material hose can cause spitting.	 To correct cause (1) back up knurled nut (E), place two drops of machine oil on packing, replace nut and tighten with fingers only. In aggravated cases, replace packing. To correct cause (2), remove fluid nozzle (F), clean back of nozzle and nozzle seat in gun body using rag wet with thinner, replace nozzle and draw up tightly against body. To correct cause (3), tighten or replace swivel nut.

SPRAY GUN CLEANING INSTRUCTIONS

In certain states it is now against the law to spray solvents containing Volatile Organic Compounds (VOC)'s into the atmosphere when cleaning a spray gun. In order to comply with these air quality laws Binks recommends one of the following two methods to clean your spray finishing equipment:

1. Spray solvent through the gun into a **closed system**. An enclosed unit or spray gun cleaning station condenses solvent vapors back into liquid form which prevents escape of VOC's into the atmosphere.
2. Place spray gun in a washer type cleaner. This system must totally enclose the spray gun, cups, nozzles and other parts during washing, rinsing and draining cycles. This type of unit must be able to flush solvent through the gun without releasing any VOC vapors into the atmosphere.

Additionally, open containers for storage or disposal of solvent or solvent-containing cloth or paper used for surface preparation and clean-up may not be used. Containers shall be nonabsorbent.

AIR AND FLUID NOZZLE CLEANING

A faulty spray pattern is often caused by improper cleaning resulting in dried materials around the material nozzle tip or in the air nozzle. Soak these parts in thinners to soften the dried material and remove with a brush or cloth.

CAUTION

Never use metal instruments to clean the air or material nozzles. These parts are carefully machined and any damage to them will cause faulty spray.

If either the air nozzle or fluid nozzle are damaged, these parts must be replaced before perfect spray can be obtained.

CLEANING GUN USED WITH 1 QUART CUP

Relieve pressure in the cup. Then, unscrew, empty and carefully rinse cup out with thinners. Place clean thinners in the cup and spray this through the gun until it is clean. Blow air through gun to dry it.

CLEANING GUN USED WITH PRESSURE CONTAINER

WARNING

Injection of material from the gun into the skin may result in serious personal injury. Shut off the air supply to the container and release the pressure on the container before attempting to clean the gun.

Hold a piece of cloth wadded in the hand over the gun nozzle and pull the trigger. The air will back up through the material nozzle and force the material out of the hose into the container. Empty container. Put enough thinners into the container to wash the hose and gun thoroughly and spray this through the gun until it is clean. Then blow out the material hose to dry it and remove all traces of material by attaching it to the air line.

CLEANING GUN USED WITH PAINT CIRCULATING SYSTEM

Shut off material supply and remove material hose from gun. Clean gun as used with siphon cup or pressure container or connect quick release on paint line solvent line. To ensure clean air to spray gun, use Binks oil and water extractor. See your Binks distributor for the correct model.

MAINTENANCE

TO REPLACE AIR VALVE AND SPINDLE ASSEMBLY

Remove material valve control knob (21), spring (18), and needle assembly (20). Unscrew housing (19), and remove spindle assembly (17) with springs (16 & 18), housings (15), and o-rings (14). Lubricate new o-rings with Gunners Mate. Assemble components using material needle. Place this assembly along with housing (19) into gun body and screw into position. Remove material needle (20) and tighten housing (19).

TO REPLACE NEEDLE SEAL AND GLAND ADAPTER IN FLUID INLET

Remove material valve control knob (21) and spring (18) and pull out fluid needle (20). Unscrew packing nut (30) and remove spring (29) and seal backup (28). Using a no. 10 x 1-1/4" coarse-thread wood screw (Binks Part No. 20-6536) or small sheet metal screw, remove the needle seal (27) and gland adapter (26). Replace gland adapter (26) and needle seal (27). Re-insert seal backup (28) spring (29) and screw on packing nut (30) a couple of turns so it fits loosely by hand. Reassemble fluid needle (20), spring (18) and material valve control knob (21). Finally, tighten packing nut (30) until it bottoms out on fluid inlet (25).

LUBRICATION

Lubricate daily, all moving parts including trigger pivot point and air valve spindle and with Binks Gunners Mate (44).

Binks Model 95 SPRAY GUN

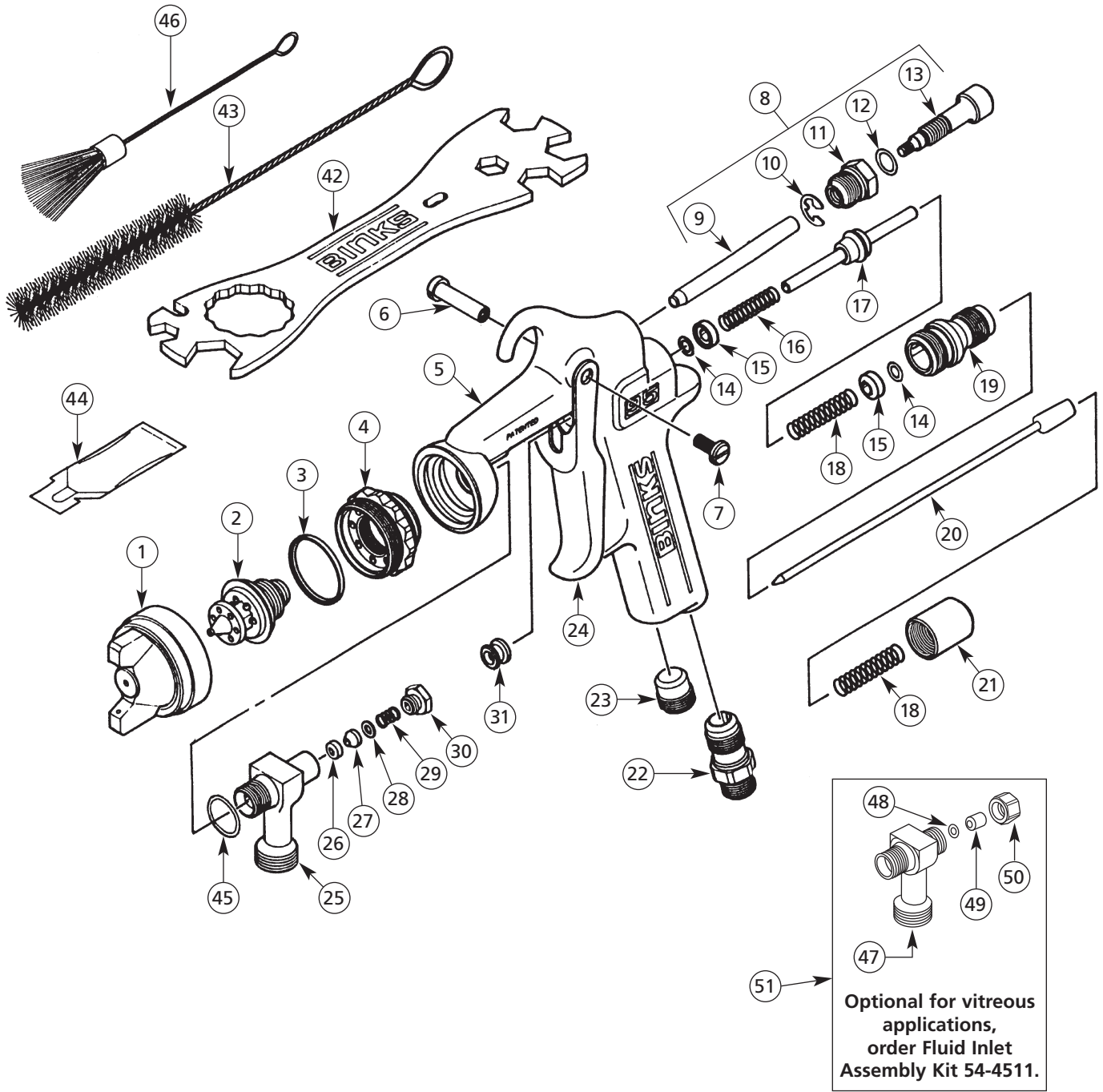

Optional for vitreous applications, order Fluid Inlet Assembly Kit 54-4511.

PARTS LIST

(When ordering, please specify Part No.)

ITEM NO.	PART NO.	DESCRIPTION	QTY.	ITEM NO.	PART NO.	DESCRIPTION	QTY.
1	*	AIR CAP ASSEMBLY	1	23	54-3504	PLUG	1
2	*	FLUID NOZZLE (Stainless Only)	1	24	54-3578	TRIGGER	1
3	54-918●■^	SEALING RING	1	25	54-4210	FLUID INLET.....	1
4	54-4215	HEAD INSERT.....	1	26	54-4264●■	GLAND ADAPTER.....	-
5	—	95 SERIES GUN HANDLE	1	27	54-4265●■	NEEDLE SEAL.....	-
6	54-3580	TRIGGER STUD	1	28	54-4266●■	SEAL BACKUP.....	-
7	54-3581	TRIGGER SCREW	1	29	54-4267●■	SPRING.....	-
8	54-4216	SIDE PORT CONTROL ASSEMBLY	1	30	54-4263●■	PACKING NUT	-
9	54-4219	CONTROL STEM	-	31	54-3513	VALVE SPINDLE CAP	1
10	54-3511■	RETAINING RING	-	43	82-469	GUN BRUSH.....	1
11	54-4218	CONTROL BODY	-	44	—	GUNNERS MATE (3cc).....	1
12	20-6160■◆	O-RING.....	-	45	54-3592●■	COPPER GASKET	1
13	54-4217	CONTROL SCREW.....	-	OPTIONAL ACCESSORIES (Please order separately)			
14	20-4615■◆^	O-RING.....	2	42	54-4213	WRENCH (Optional).....	1
15	54-3515	HOUSING	2	46	OMX-88	GUN BRUSH (Optional).....	1
16	54-3520■◆	SPRING (Yellow).....	1	—	6-429	GUNNERS MATE (20 ea. 2 oz. bottles)	1
17	54-3512■◆	SPINDLE ASSEMBLY	1	OPTIONAL SPRINGS (Please order separately)			
18	54-3518■◆	SPRING (Blue – 6 lbs., 8 oz.)	2	18	54-4427	HEAVY DUTY SPRING (29 lbs.).....	1
19	54-3541	HOUSING	1				
20	*	FLUID NEEDLE (Stainless Only).....	1				
21	54-3606	MATERIAL VALVE CONTROL KNOB	1				
22	54-768	AIR CONNECTION	1				

* See Air Cap, Fluid Nozzle, and Needle Selection Chart page 8.

■ Part of Repair Kit 54-3577 (Fluid Inlet and Air Valve Kit). Available only as a part of its assembly.

● Part of Repair Kit 54-4225 (Fluid Inlet Packing Kit).

◆ Part of Repair Kit 54-4226 (Air Valve Spindle Kit).

^ Part available separately in package of 5 (add -5 to part number).

FOR VITREOUS APPLICATIONS – PLEASE ORDER SEPARATELY

ITEM NO.	PART NO.	DESCRIPTION	QTY.	ITEM NO.	PART NO.	DESCRIPTION	QTY.
47	54-4568▲	FLUID INLET.....	1	49	54-4531▲●■	PACKING SPACER.....	1
48	20-2227▲●■	O-RING.....	1	50	54-4542▲	NUT ASSEMBLY	1
				51	54-4511▲	FLUID INLET ASSEMBLY (VITREOUS)....	1

▲ Part of Fluid Inlet Assembly Kit 54-4511 (optional for vitreous applications).

● Part of Repair Kit 54-4225 (Fluid Inlet Packing Kit).

■ Part of Repair Kit 54-3577 (Fluid Inlet and Air Valve Kit). Available only as a part of its assembly.

SEE PAGE 8 FOR OPTIONAL NOZZLE SETUPS

NOZZLE and NEEDLE SELECTION CHARTS

TYPE OF FLUID TO BE SPRAYED	FLUID X AIR NOZZLES	NOZZLE TYPE	CFM AT			MAX PATTERN AT 8"	FLUID NEEDLE NOS. FOR SPRAY GUN MODEL 95
			30 PSI	50 PSI	70 PSI		
VERY THIN 14-16 secs. Zahn 2 Cup Wash primers, dyes, stains, solvents, water, inks	63ss x 63P	PE	4.5	7.5	10.0	5	663
	63Bss x 63PB	PE	9.0	14.3	20.0	14	663A
	66ss x 66SD	SE	7.9	12.1	—	10.5	665
	66ss x 66SK	SE	11.0	15.2	19.5	13	665
	63Bss x 200	PI	3.1	5.2	6.4	12	663A
THIN 16-20 secs. Zahn 2 Cup Sealer, lacquers, primers, inks, lubricants, zinc chromates, acrylics	63Ass x 63P	PE	5.1	8.37	12.2	11	663A
	63Bss x 63PE	PE	9.5	15.0	20.0	13	663A
	66ss x 66SK	SE	11.0	15.2	19.5	13	665
	63Bss x 200	PI	3.1	5.2	6.4	12	663A
MEDIUM 19-30 secs. Zahn 2 Cup Synthetic enamels, varnishes, shellacs, fillers, primers, epoxies, urethanes, lubricants, wax emulsions, enamels	63Bss x 63PB	PE	9.0	14.3	20.0	14	663A
	63Css x 63PE	PE	9.5	15.0	20.0	13	663A
	66ss x 66SD	SE	7.9	12.1	—	11	665
	66ss x 66SK	SE	11.0	15.2	19.5	13	665
	63Css x 200	PI	3.1	5.2	6.4	12	663A
HEAVY (Cream-like) Over 28 secs. No. 4 Ford Cup	67ss x 67PB	PE	9.5	14.9	19.5	12	667
	68ss x 68PB	PE	9.5	14.1	19.1	12	668
	67ss x 206	PI	6.0	9.5	13.0	15	667
VERY HEAVY Texture coatings, Road marking paint	68ss x 68PB	PE	9.5	14.1	19.1	12	668
	68ss x 206	PI	6.2	9.8	13.2	15	668
	59Ass x 244	PI	7.8	11.5	15.2	12	659
	59Ass x 245	PI	7.8	11.5	15.2	6	659
	59Bss x 251	PI	7.8	11.5	15.2	12	659
	59Bss x 252	PI	7.8	11.5	15.2	6	659
	59Css x 262	PI	7.3	11.0	14.7	6	659
	68ss x 206	PI	6.2	9.8	13.2	15	668
ADHESIVES Waterbase white vinyl glues Solvent base, neoprenes (contact cement)	63Bss x 66SD-3	PE	7.9	12.1	16.2	4	663
	67ss x 67PB	PE	9.5	14.1	19.1	12	667
	66ss x 66SD-3	PE	7.9	12.1	16.2	10	665
	66ss x 66SDJG	PE	10.4	—	—	8-9	665
	66ss x 66R	PE/SE	—	4.2	—	RD	665
	L6SS x 66SD-3	PE	9.5	14.2	19.0	10	665
	L3BSS x 66SD-3	PE	9.5	14.2	19.0	10	663A
CERAMICS Similar abrasive materials, glazes, engobes, porcelain enamel	67VT x 67PD	PE	10.0	15.0	20.0	15	667VT
	68VT x 68PB	PE	9.5	14.1	19.1	12	668VT
BUFFING COMPOUNDS	64VT x 64PA	PE	12.1	15.0	21.0	13	664VT
	67VT x 67PD	PE	10.0	15.0	20.0	15	667VT
CONCRETE CURING COMPOUNDS	66ss x 200	PI	3.1	5.2	6.4	15	665
	67ss x 206	PI	6.0	9.5	13.0	18	667
	68ss x 206	PI	6.2	9.8	13.2	20	668
MULTICOLOR PAINTS	66ss x 200	PI	3.1	5.2	—	12	665
	67ss x 206	PI	6.0	9.5	—	15	667
	66ss x R3	PI	—	4.2	—	FAN	665
	66ss x R8	PI	—	4.2	—	FAN	665
PTFE	63Ass x 63PB	PE	9.0	14.3	20.1	10	663A
	66ss x 66SD	PE	7.9	12.1	—	7	665
HAMMERS	63ss X 63PB	PE	9.0	14.3	—	14	663A
	66ss X 63PB	PE	9.0	14.3	—	14	665
	66ss X 66SD	PE	7.9	12.1	—	7	665
WRINKLE ENAMELS	63Css x 63PB	PE	9.0	14.3	20.0	10	663A
	66ss x 63PB	PE	9.0	14.3	20.0	10	665
ZINC RICH COATINGS	66ss x 67PD	PE	12.0	18.0	24.0	15	665N
	67VT x 67PB	PE	9.5	14.1	19.1	12	667VT

Note: PE - Pressure External SP - Siphon External PI - Pressure Internal

Nozzle No.	59ASS	59BSS	59CSS	63SS	63ASS	63BSS	63CSS	65SS	66SS	67SS	68SS
Orifice Size	.171	.218	.281	.028	.040	.046	.052	.059	.070	.086	.110

SPECIAL NOZZLES – INTERNAL MIX HEAVY MATERIAL

SEE CHART AIR & FLUID NOZZLES

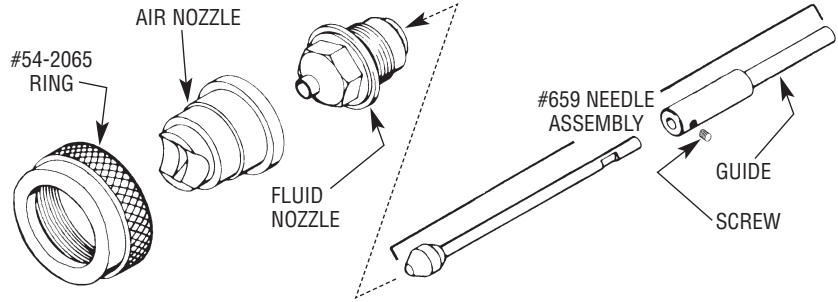
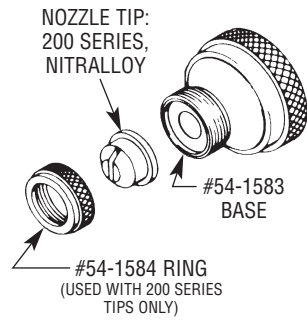

SPECIAL NOZZLE – CLEANING



#54-928 10" CLEANING ATTACHMENT
(REQUIRED FOR DEGREASING AND LUBRICATING)

WARRANTY

This product is covered by Binks' 1 Year Limited Warranty.

Binks Sales and Service: www.binks.com



U.S.A./Canada Customer Service
ITW Finishing Equipment Americas
195 Internationale Blvd.
Glendale Heights, IL 60139
630-237-5000

Toll Free Customer Service
and Technical Support
800-992-4657
Toll Free Fax
888-246-5732

77-2625R-9 Revisions: (P7) Updated Parts List;
(P9) Deleted Multi-color Conversion Kit;
(P12) Updated contact information.